

Quantum Computing Architectures

Budapest University of Technology and Economics 2018 Fall

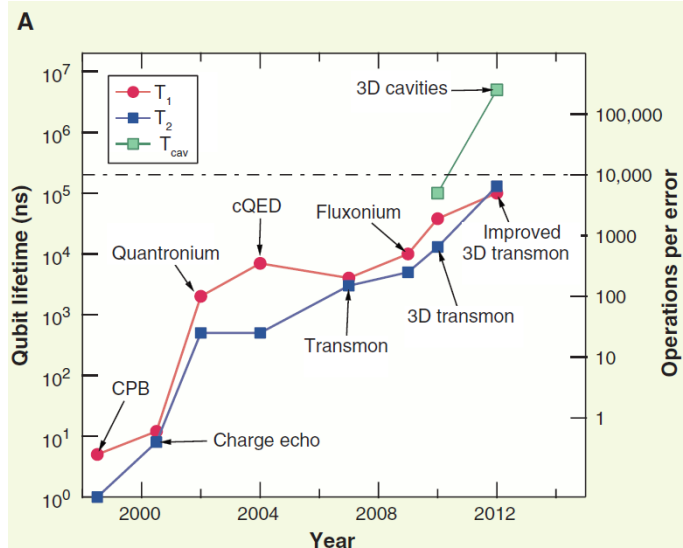

Lecture 7: Superconducting qubits
 Basic architectures 2
 Flux and charge qubits
 cQED

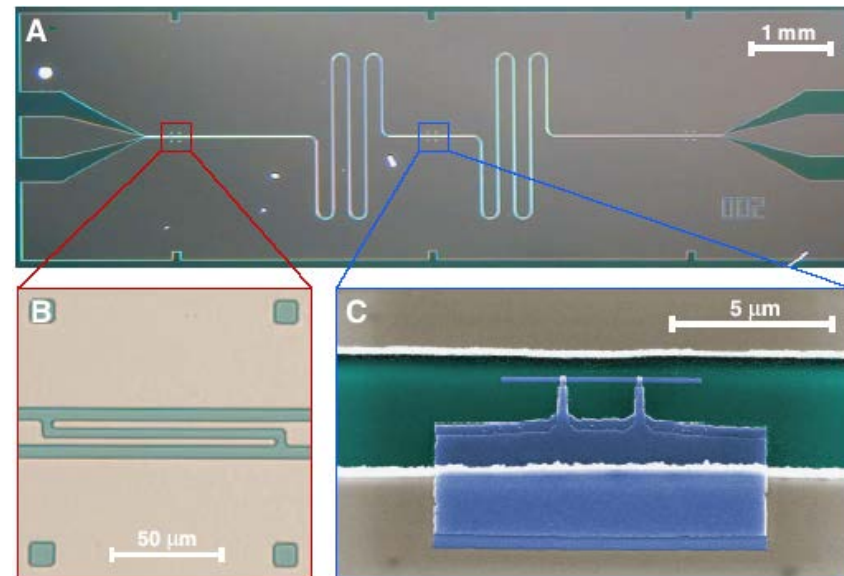
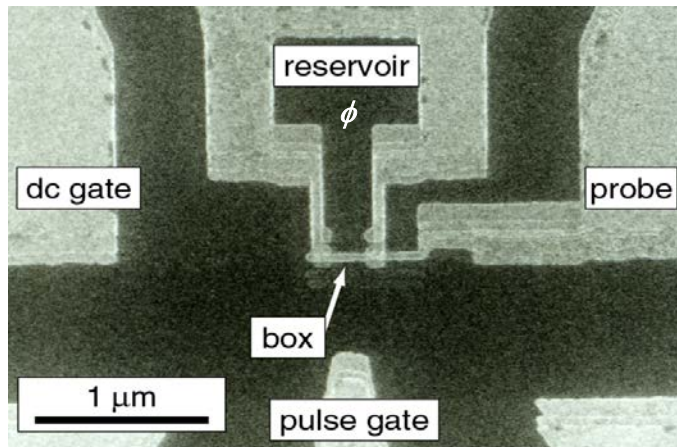

RF SQUID

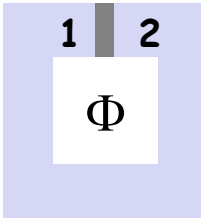

L loop inductance

Similarly to DC SQUID the phase difference equals the flux inside the loop

$$\frac{\Phi_0}{2\pi}(\phi_1 - \phi_2) = \int_1^2 \vec{A} d\vec{l}$$

$$\delta = \phi_1 - \phi_2 = \frac{2\pi\Phi}{\Phi_0}$$

The flux inside the loop will be partially screened by and induced circulating current

$$\Phi = \Phi_{ext} - LI_{circ}$$

Equation of motion, with the calculated current:

$$0 = C \frac{\Phi_0}{2\pi} \frac{d^2\delta}{dt^2} + \frac{\Phi_0}{2\pi} \frac{1}{R} \frac{d\delta}{dt} - I_c \sin(\delta) - \frac{1}{L} \left(\frac{\hbar}{2e} \delta - \Phi_{ext} \right)$$

$$U(\delta) = \frac{\Phi_0}{2\pi} I_c (1 - \cos(\delta)) + \frac{1}{2L} \left(\frac{\hbar}{2e} \delta - \Phi_{ext} \right)^2$$

Potential – junction + magnetic energy

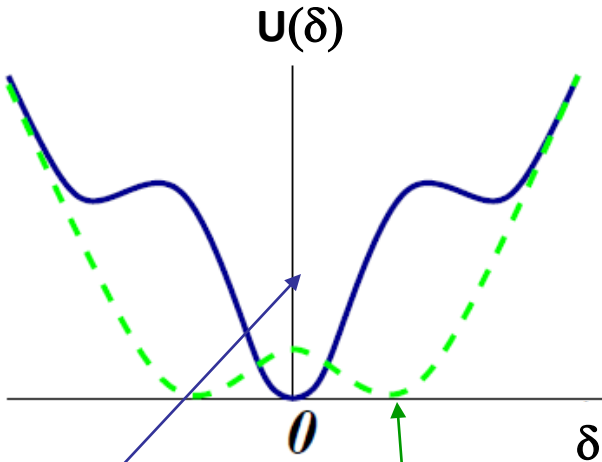

integer bias flux

half-integer bias flux

At half quanta the circulating current changes sign and a flux quanta jumps into the loop

For half integer quantum, two minima:

two persistent current states, circulating in different direction

RF SQUID

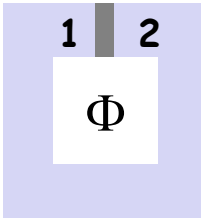

L loop inductance

Single-junction loop: rf-SQUID / Flux qubit

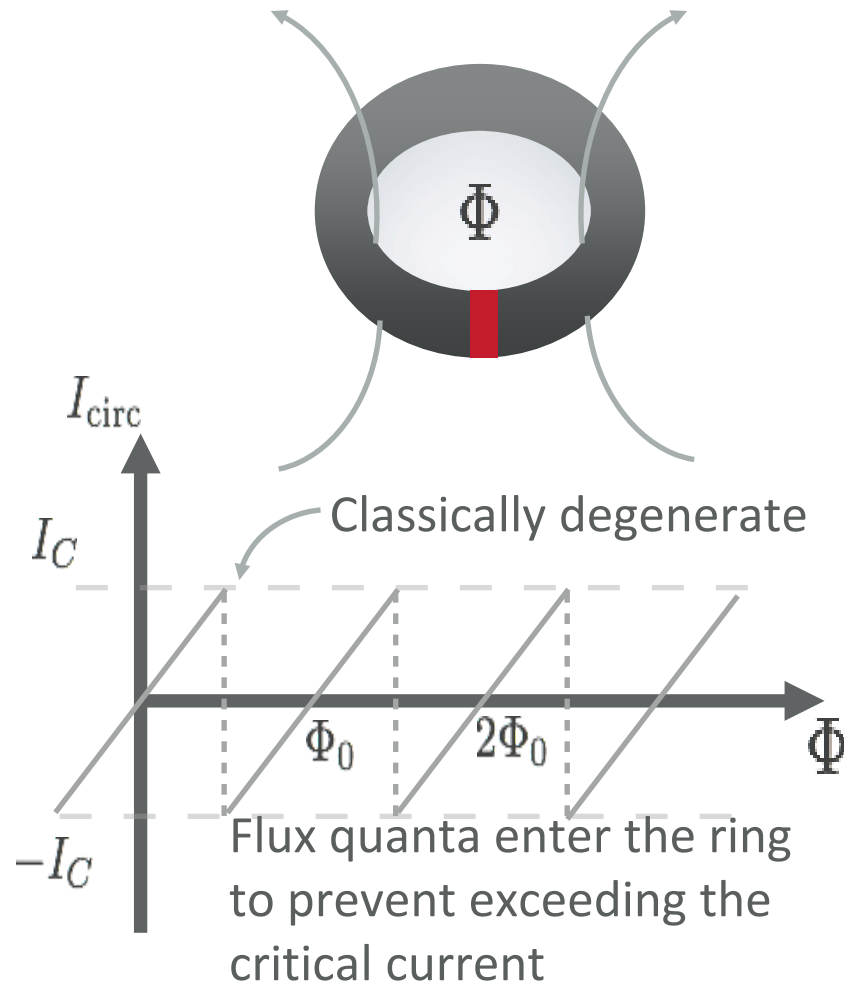

1 2

Φ

Flux qubit

$$U(\delta) = \frac{\Phi_0}{2\pi} I_c (1 - \cos(\delta)) + \frac{1}{2L} \left(\frac{\hbar}{2e} \delta - \Phi_{ext} \right)^2$$

Two wells \rightarrow two levels – for symmetric potential degenerate flux states
 The two states correspond to oppositely circulating persistent current
 If tunneling is possible between the two wells (Δ), states hybridize and split up and the macroscopic tunneling determines the separation

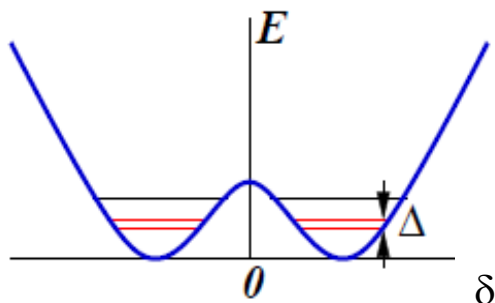

potential for half integer flux bias

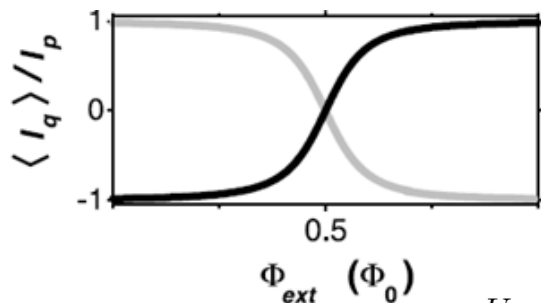

The expectation value of the current as a function of the flux
 Away from half flux quanta, pure flux states

$$U = -E_j [\cos(\varphi_1) + \cos(\varphi_2) + \alpha \cos(\varphi_1 - \varphi_2 - 2\pi\Phi_{ext}/\Phi_0)]$$

Hard to fabricate, big loop is needed for inductance matching (large noise pickup possible big decoherence) \rightarrow 3 JJ-s qubit (effectively the same).

$$\varphi_1 + \varphi_2 + \varphi_3 + 2\pi\Phi/\Phi_0 = 2\pi n$$

the potential is parabolic on the white intersection α tunes the macroscopic quantum tunneling.

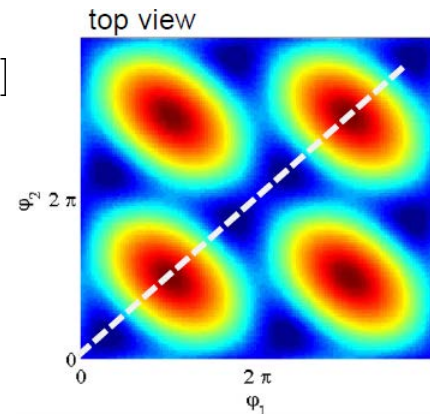
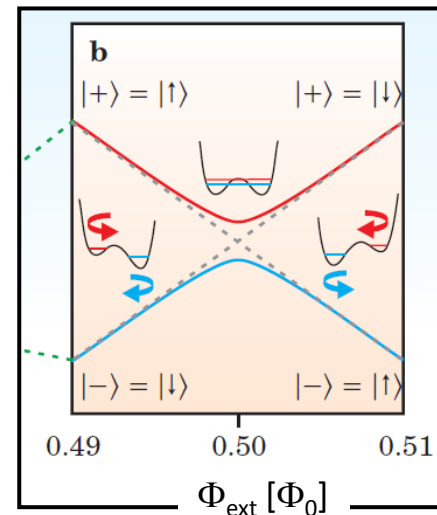

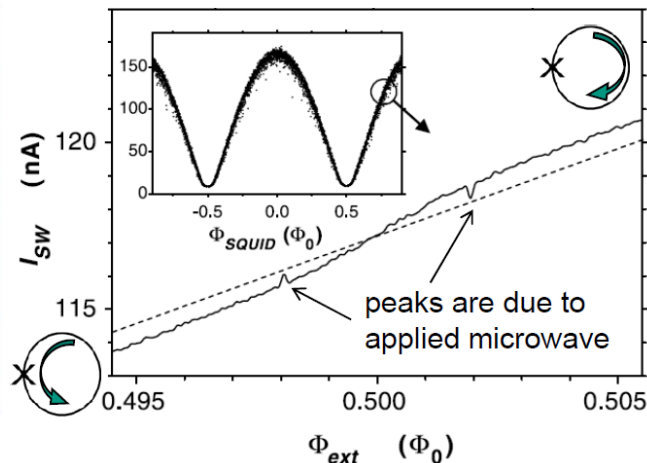
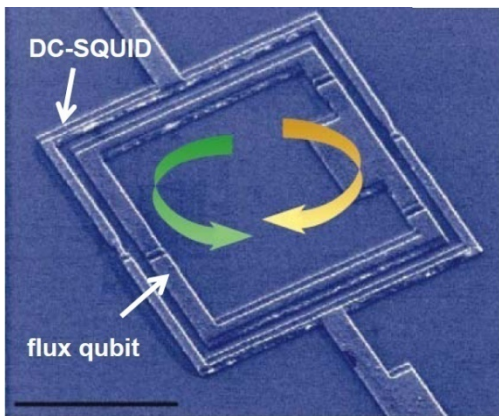

Readout – by DC SQUID measuring the opposite supercurrents in the qubit. Measurement with SQUID – measure the switching currents

During the sweeping of the magnetic field, microwave applied. transition causes supercurrent flowing opposite direction → change in field measured by squid (change in switching current)

- the resonance seen for different frequencies at different flux points.
- peaks indicate switching between flux states
- the excitation spectra is nicely reproduced
- at zero detuning the avoided crossing of the two levels is extrapolated

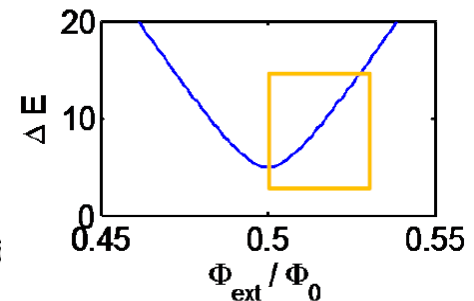
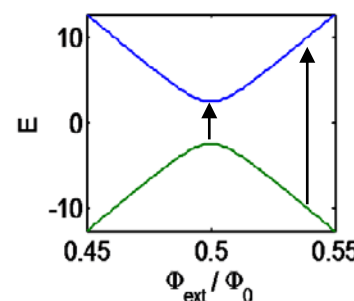
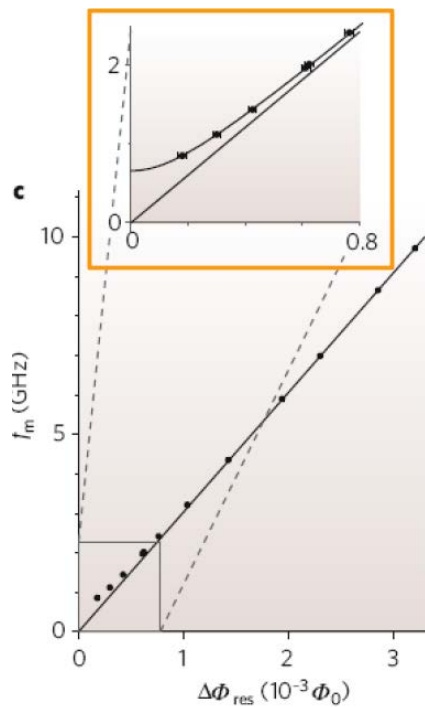
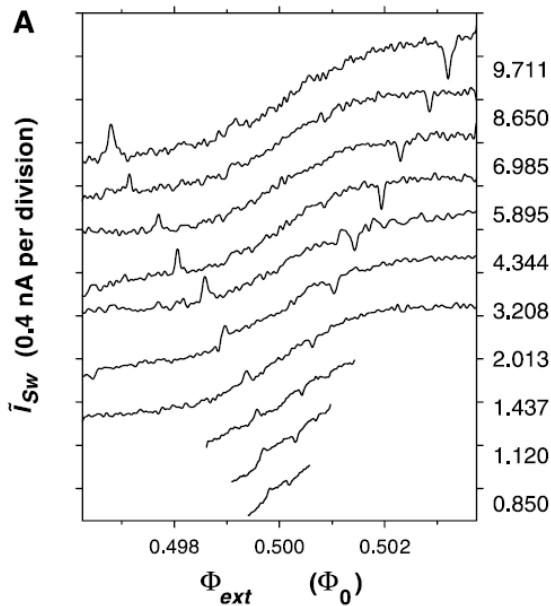

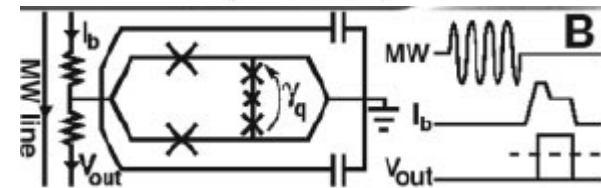
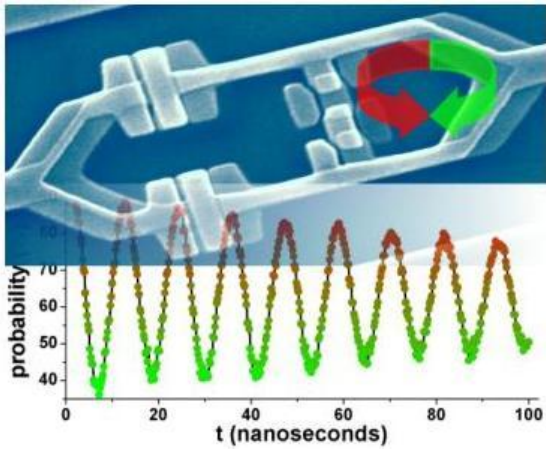

Other design: squid is directly coupled to achieve higher sensitivity
 $T_1 \sim 900\text{ns}$, $T_2 \sim 20\text{-}30\text{ ns}$
 Dephasing: likely flux noise \rightarrow changes the qubit frequency randomly

Ideal operation would be at $\Phi = \pi$, however this did not work for these devices.
 There $\delta E \sim \Phi^2$, less sensitive to flux noise \rightarrow sweet spot

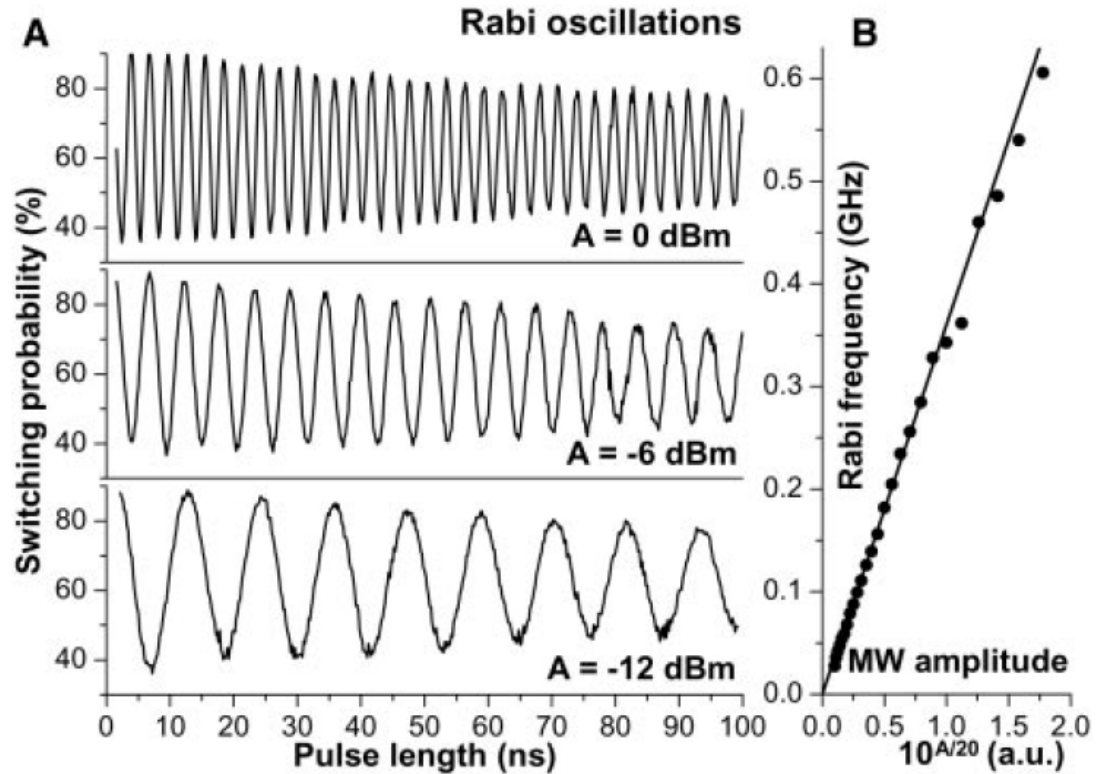

S_1 **I** S_2

$$\delta = \phi_2 - \phi_1$$

RCSJ model – energy terms

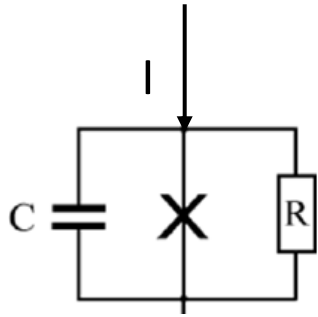

Neglect damping. SC state. $R=0$

$$E=K+U$$

$$K = \frac{1}{2}CV^2 = \frac{Q^2}{2C} = \frac{1}{2}C \left(\frac{\hbar}{2e} \right)^2 \left(\frac{d\delta}{dt} \right)^2$$

or using

$$M = \frac{\hbar C}{2e}$$

$$U = E_{J0}(1 - \cos(\delta))$$

$$E_{J0} = I_C \frac{\hbar}{2e}$$

Josephson energy

$$E_C = \frac{e^2}{2C} \quad \text{Charging energy}$$

$$\hbar\omega_{pl} = \sqrt{8E_C E_{J0}}$$

$$\hbar\omega_{pl} \ll E_{J0}$$

Classical treatment valid:
Oscillation only in the bottom of the potential well

$$E_C \ll E_{J0}$$

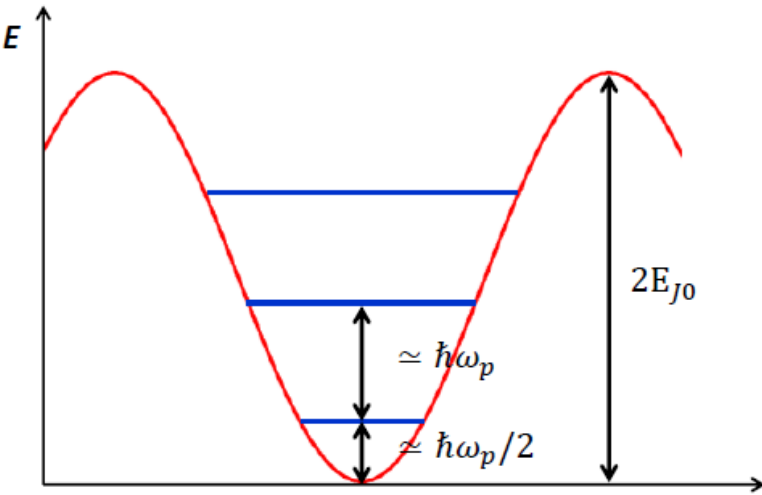

Homework: How to enter the quantum regime? Investigate scaling with the junction area. Suppose $d=1\text{nm}$, $\epsilon=10$, $I_c=100\text{ A/cm}^2$. What is the temperature range where the measurement should be done?

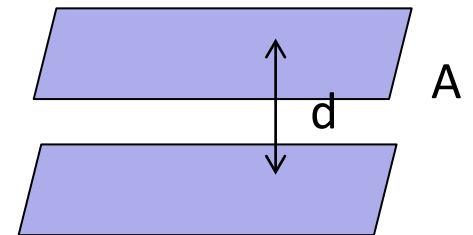

Energy terms

Why JJ, not a simple inductor?

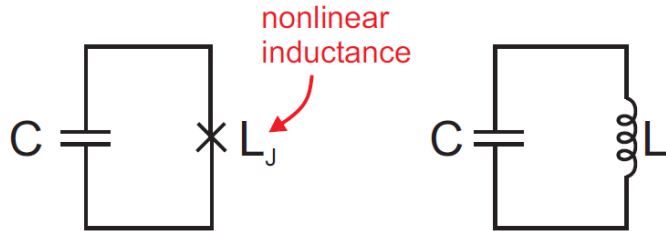

Josephson junctions is a *non-linear inductance*: the energy spectra is anharmonic. The qubit can be separated from excited states

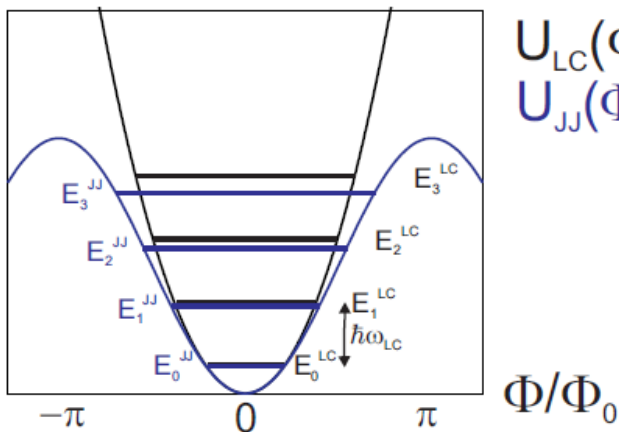

LC - oscillator

$$H = \frac{1}{2}CV^2 + \frac{1}{2}LI^2 \quad V = L \frac{dI}{dt} \quad \Phi = LI$$

$$I = C \frac{dV}{dt} \quad Q = CV$$

Josephson junction

$$I = I_c \sin(\delta) = I_c \sin(2\pi\Phi/\Phi_0)$$

$$\frac{dI}{dt} = L_J^{-1}V \quad L_J^{-1} = \frac{2\pi I_c}{\Phi_0} \cos(2\pi\Phi/\Phi_0)$$

for small Φ $L_J = \frac{\Phi_0}{2\pi I_c} \quad I \simeq \frac{\Phi}{L_J}$

$$H = \frac{1}{2}CV^2 + \frac{1}{2}L_J I^2 = \frac{Q^2}{2C} + \frac{1}{2L_J}\Phi^2$$

Why else superconductors?

- Single non-degenerate macroscopic ground state
- no low energy excitations

Quantization of EM circuits

$$H = E + K = \frac{p^2}{2m} + \frac{1}{2}m\omega_{pl}^2 = \frac{Q^2}{2C} + \frac{1}{2L_J}\Phi^2 \quad \text{Energy of a harmonic oscillator}$$

$$H = E + K = \frac{1}{2}C \left(\frac{\hbar}{2e} \right)^2 \left(\frac{d\delta}{dt} \right)^2 + E_{J0}(1 - \cos(\delta)) \quad \text{JJ: nonlinear Harmonic oscillator}$$

$$p = mv = C \left(\frac{\hbar}{2e} \right)^2 \frac{d\delta}{dt} \quad \text{Knowing the mass, identify momentum} \quad M = \left(\frac{\hbar}{2e} \right)^2 C$$

Quantization – using the momentum and position operators

$$\hat{p}_\delta = \frac{\hbar}{i} \frac{d}{d\delta} \quad \hat{x} = \hat{\delta} \quad \longrightarrow \quad [\hat{\delta}, \hat{p}_\delta] = i\hbar$$

$$\hat{H} = -4E_c \frac{d^2}{d\delta^2} + E_{J0}(1 - \cos(\delta))$$

Quantized JJ Hamiltonian

Phase representation (analogous to coordinate repr.)

Charge, Cooper pair number, flux basis

Homework:

$$Q = C \frac{\hbar}{2e} \frac{d\delta}{dt}$$

$$\hat{N} = -i \frac{d}{d\delta}$$

$$[\hat{\delta}, \hat{N}] = i$$

CP number

$$\hat{\Phi} = \frac{\hbar}{2e} \hat{\delta}$$

$$[\hat{\Phi}, \hat{Q}] = i\hbar$$

Flux

$$\hat{Q} = -2ei \frac{d}{d\delta}$$

charge

$$\Delta N \Delta \delta \geq 1$$

Either phase (flux) or number of Cooper pairs (charge) is well defined
 → Phase or charge regime

$$\Delta N \Delta \delta \geq 1$$

1) Phase regime $\hbar\omega_{pl} \ll E_{J0}$ and $E_C \ll E_{J0}$

phase is well localized in one of the minima, large charge fluctuations are possible (small E_C)

2) Charge regime $\hbar\omega_{pl} \gg E_{J0}$ and $E_C \gg E_{J0}$

e.g. a small island tunnel coupled, number of states well localized (Coulomb blockade), phase fluctuations are large

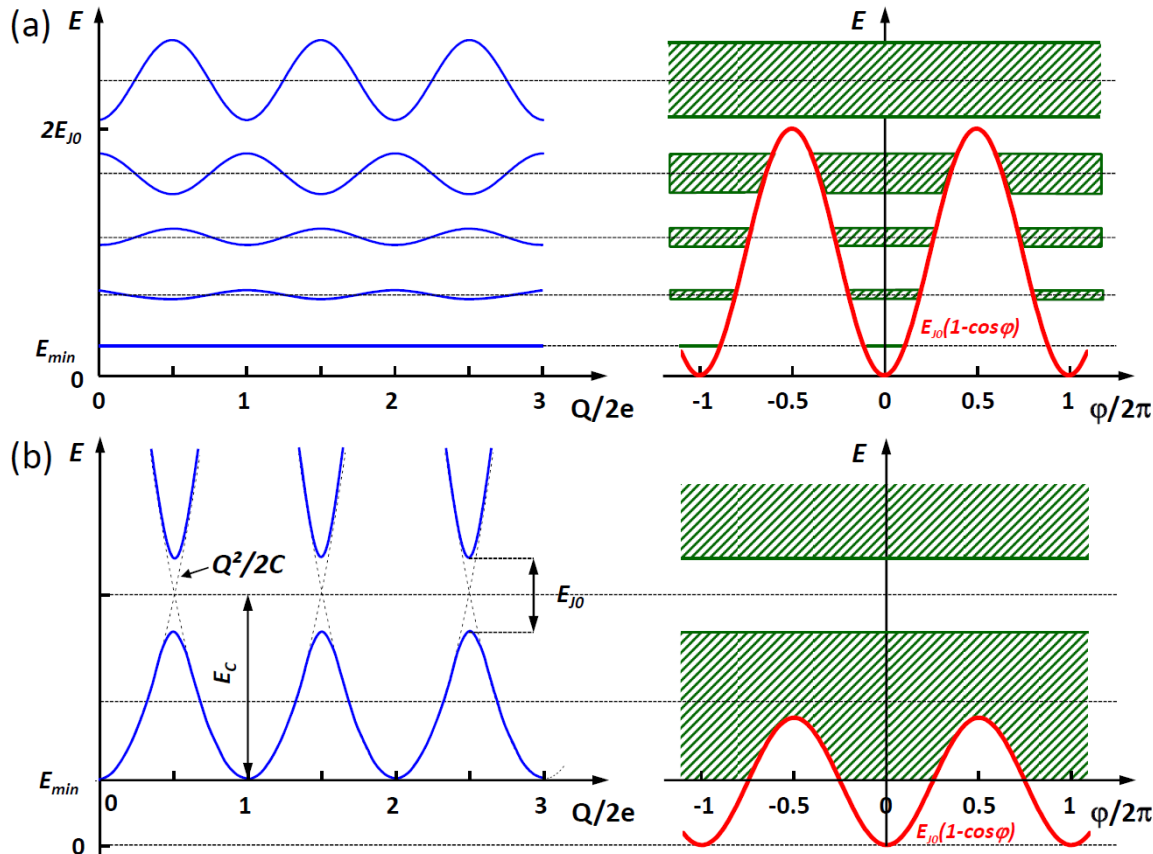

Analogous to the problem of electrons in a periodic potential

Strong phase potential \rightarrow localized states (in phase)

Weak phase potential \rightarrow extended states in phase space

Charge qubits

$$\hat{H} = \frac{\hat{Q}^2}{2C} + E_{J0} \left(1 - \cos \left(\frac{2\pi\hat{\Phi}}{\Phi_0} \right) \right) = E_c \hat{N}^2 + E_{J0} \left(1 - \cos(\hat{\delta}) \right)$$

Hamiltonian: nonlinear oscillator

$$\hat{H} = -4E_c \frac{d^2}{d\delta^2} + E_{J0}(1 - \cos(\delta))$$

Phase representation ($\sim x$ repr.)

$$|\delta\rangle = \sum_{N=-\infty}^{\infty} e^{iN\delta} |N\rangle \longleftrightarrow |N\rangle = \frac{1}{2\pi} \int_0^{2\pi} e^{-iN\delta} |\delta\rangle$$

Number representation ($\sim k$ repr.). Transformation: Fourier transform

Homework to show: $e^{i\hat{\delta}} |N\rangle = |N - 1\rangle$

$$\hat{H}_J \approx E_J \cos(\delta) = -\frac{E_J}{2} \sum_N |N\rangle \langle N+1| + |N+1\rangle \langle N|$$

Josephson term in number basis (neglecting constant offset)

$$\hat{H} = E_c \sum_N (N - N_g)^2 |N\rangle \langle N| - \frac{E_J}{2} \sum_N |N\rangle \langle N+1| + |N+1\rangle \langle N|$$

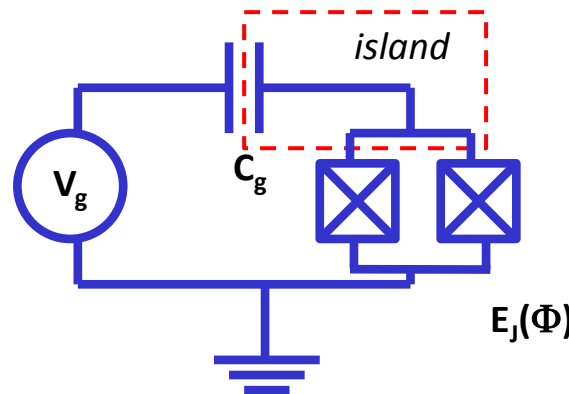
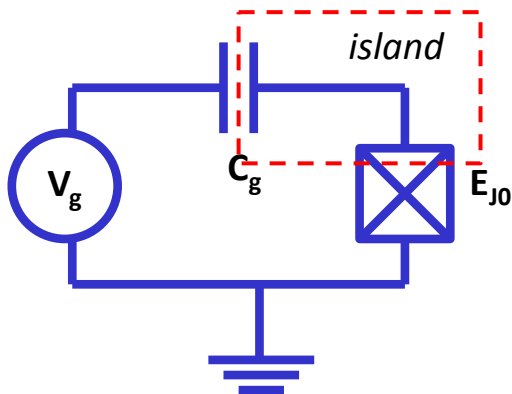

N_g : offset charge from gate electrode
Enchance E_c : make a small SC island

Charge qubit/Cooper pair box – small SC island connected with a single lead to an large SC, and to a gate electrode. The island has large charging energy. Using a SQUID loop E_j is flux tunable

$$\hat{H} = E_c \sum_N (N - N_g)^2 |N\rangle \langle N| - \frac{E_J}{2} \sum_N |N\rangle \langle N+1| + |N+1\rangle \langle N|$$

If $E_c \gg E_J$: well defined charge states. The Josephson term connect neighbouring charge occupations (measured in $2e$ – Cooper pair tunneling!)

Good ground state: good for initialization, charge states are far

Good qubit: degeneracy points: 2 levels close by next level far away

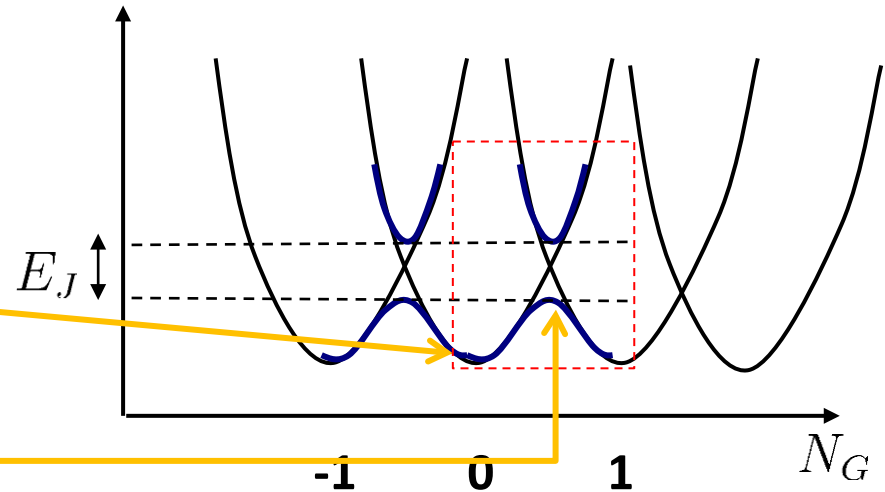

$$N_g = \frac{1}{2} + \Delta_g$$

... To check. Up to constant terms:

$$H = E_C \Delta_g \sigma_z - \frac{E_J}{2} \sigma_x = \begin{pmatrix} E_C \Delta_g & -E_J/2 \\ -E_J/2 & E_C \Delta_g \end{pmatrix} \longrightarrow E = \pm \frac{E_J}{2} \sqrt{1 + \frac{4E_C^2 \Delta_g^2}{E_J^2}}$$

Around the splitting the spectrum is quadratic:

$$\frac{4E_C^2 \Delta_g^2}{E_J^2} \ll 1 \quad \Delta E = E_J + O(\Delta_g^2)$$

Charge qubits Experiments

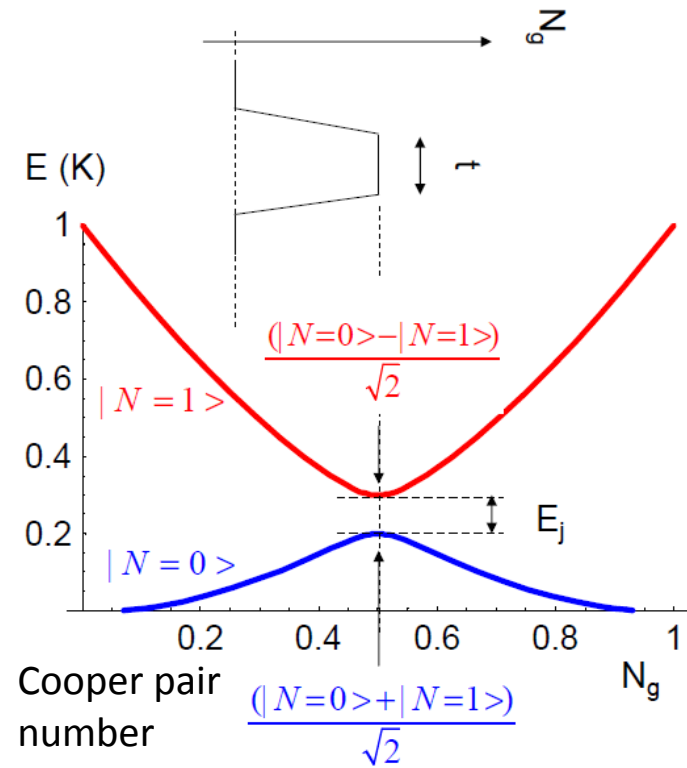
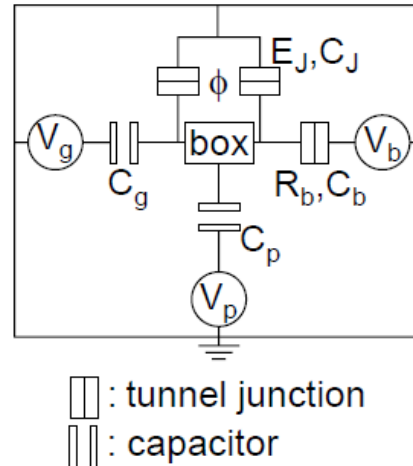
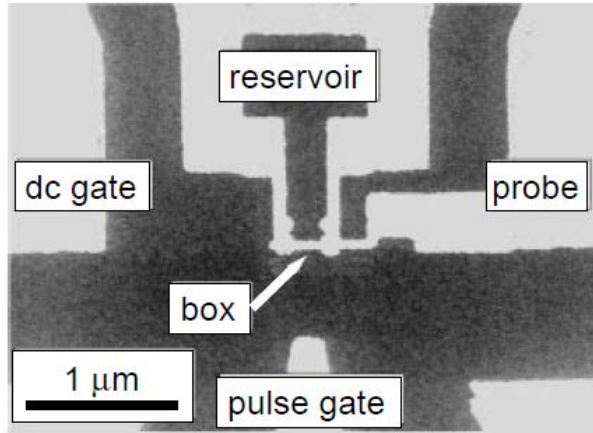

- First the qubit is prepared in state $|0\rangle$ by relaxation at $N_g=0$ (σ_z eigenstate)
- Fast DC pulse to the gate to $N_g=0.5 \rightarrow$ not adiabatic, it remains in $|0\rangle$. This is not an eigenstate (eigenstates are of σ_x)
- It starts Rabi-oscillating between $|+\rangle$ and $|-\rangle$, and evolves during the pulse length (t). After time t , bring it back to $N_g=0$
- In Larmor language: $N_g=0$, B_z field, and a \downarrow is prepared. Then B rotated fast to B_y . Larmor precession in the x - z plane. Then measurement again at B_z basis.
- Detection: If after the pulse, the qubit is in $|1\rangle$ decays to probe electrode (properly biased) through 2 quasi particle tunneling events - **single shot readout**
- By adjusting t , the length of the pulse Rabi oscillation is seen
- Relaxation <5 ns, probably due to charge fluctuations

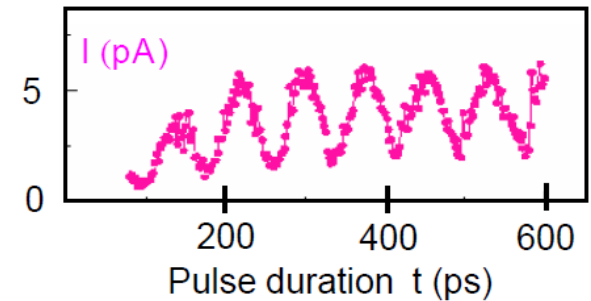

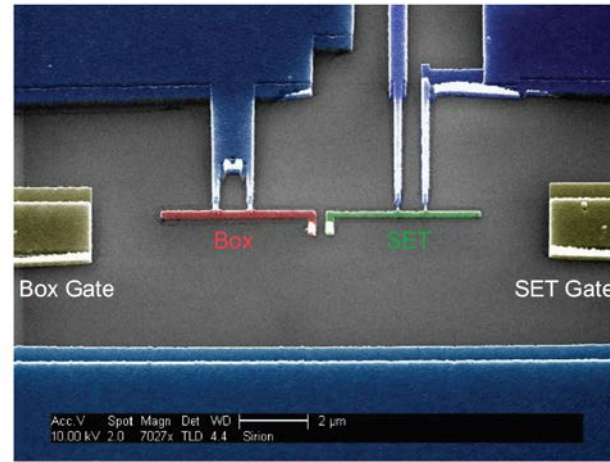
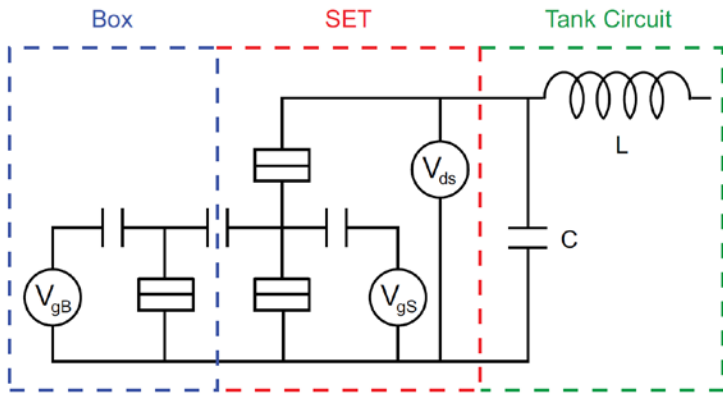

Julia Love, PhD Thesis

Other readout for charge qubit: with SET

SETs are capacitively coupled to the CPB. The change of the number of electrons on the CPB shifts the levels of the dot. The transport through the dot is measured. Or, SET coupled to RF circuit, and frequency shift of the resonator is measured.

Decoherence: limited by charge noise – $1/f$ noise. This gives fluctuation in gate voltage (not stable instruments, fluctuations in tunnel barriers, nearby trap charges), which changes the qubit energy splitting a lot \rightarrow leads to small T_2 (high frequency noise enters T_1). The least sensitive to noise at degeneracy point. Here $\delta E \sim n_g^2$, only quadratically sensitive to noise: **sweet spot**

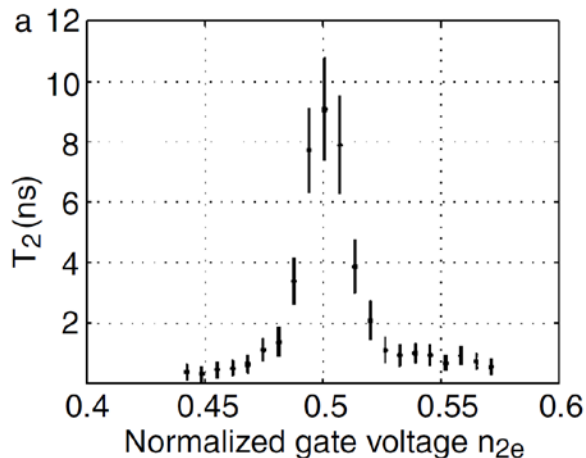

K. Bladh et al, New J. Phys. 7 180 (2005)

Best numbers:

$T_1 \sim 7 \mu s$

$T_2 \sim 500 \text{ ns @ sweet spot}$

A. Wallraff et al., Phys. Rev. Lett. 95, 060501 (2005)

Transmon regime

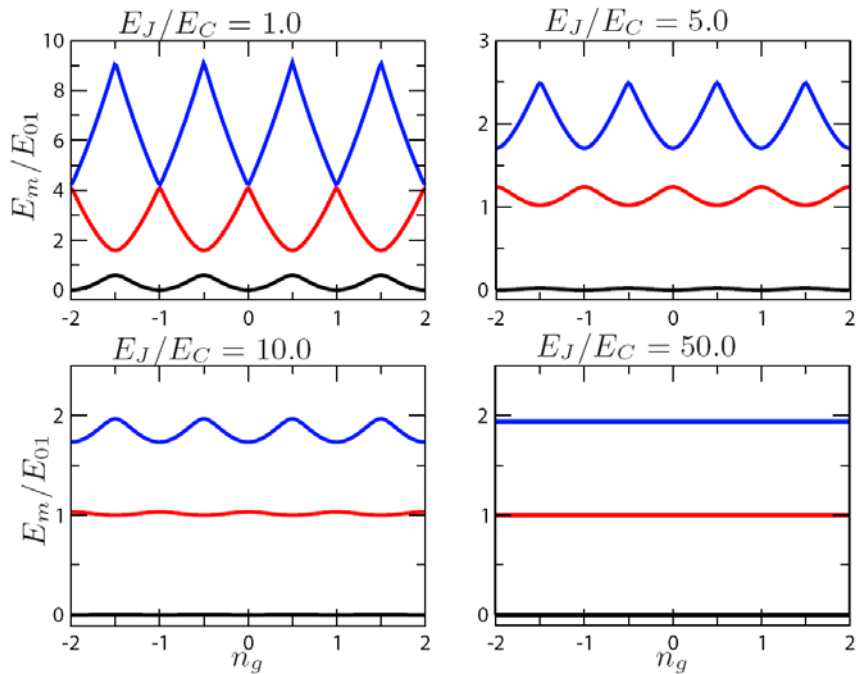

Idea: flatten the dispersion relation such, that the it becomes a **sweet spot everywhere**

Increase E_J/E_C ratio – technically done by make a large parallel capacitance (than E_J is not tuned) – increase C , decrease E_C

How does this change the

- Charge dispersion? – decreases, becomes flat
- Anharmonicity? - decreases

Anharmonicity –decreases linearly

$$\alpha_r = \frac{E_{12} - E_{10}}{E_{10}} = \sqrt{\frac{E_C}{8E_J}}$$

Charge dispersion – decreases exponentially (m: band index)

$$\epsilon_m = E_m(n_g = 1/2) - E_m(n_g = 0) \sim e^{-\sqrt{8E_J/E_C}}$$

$E_J/E_C \sim 50$ ideal

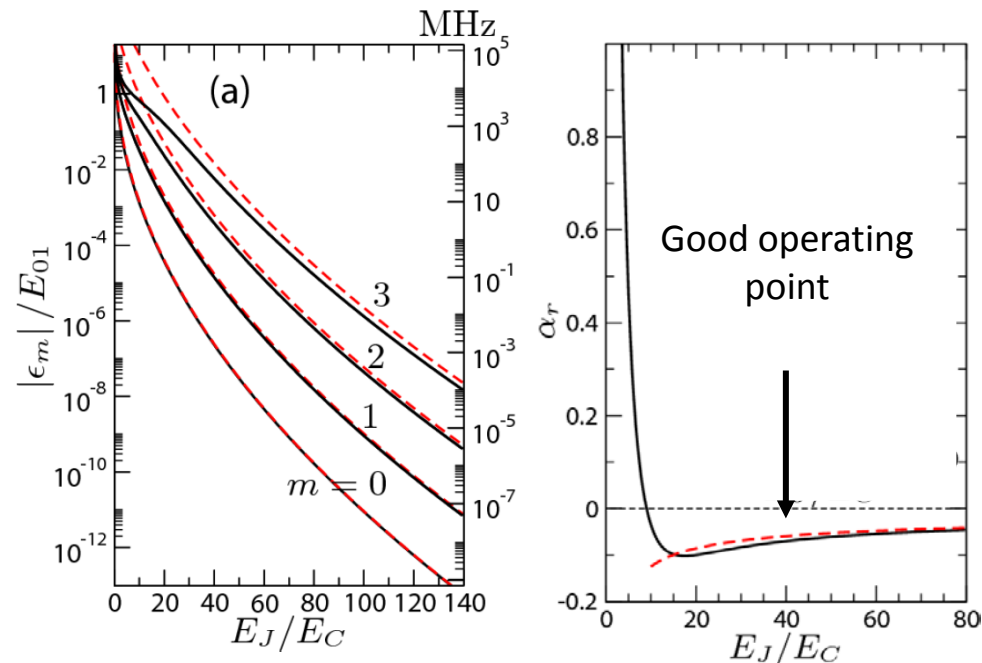

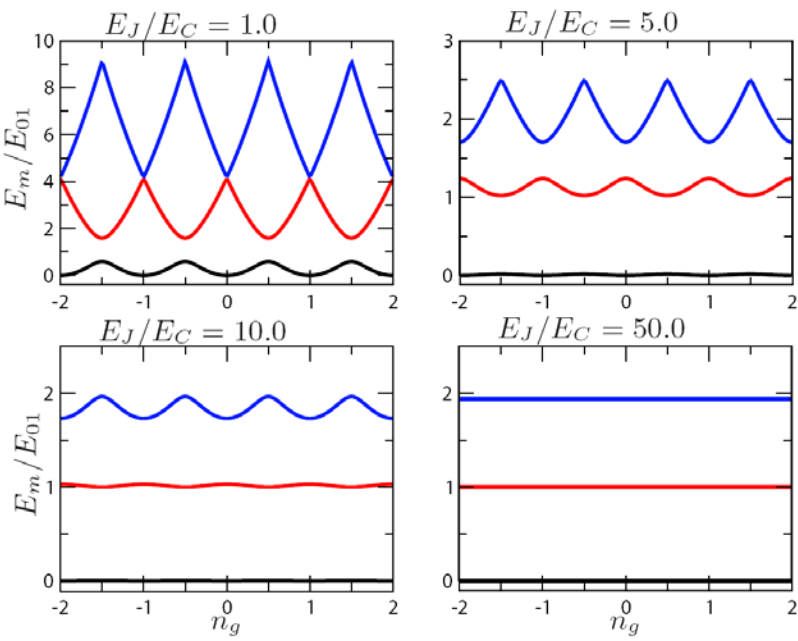

Charge becomes localized, phase compact in $[0, 2\pi]$
 Energies flux tunable

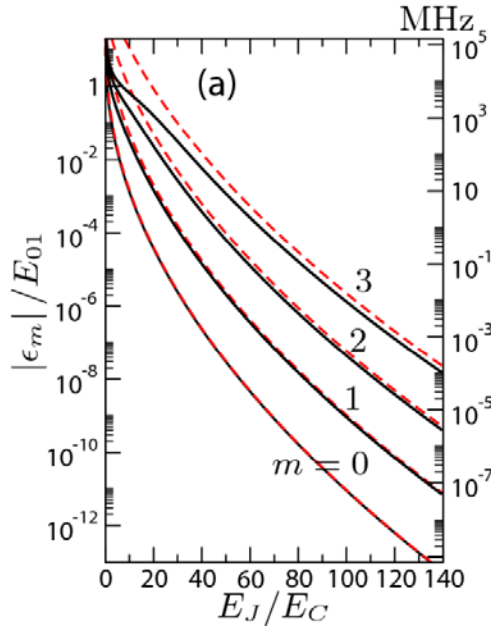
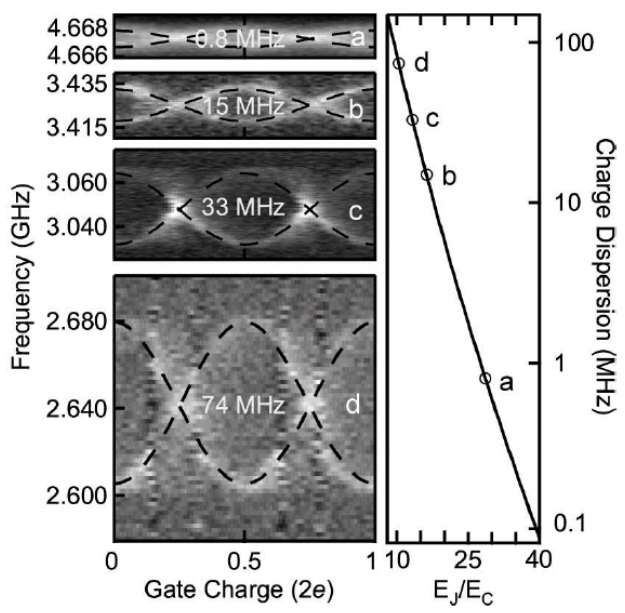
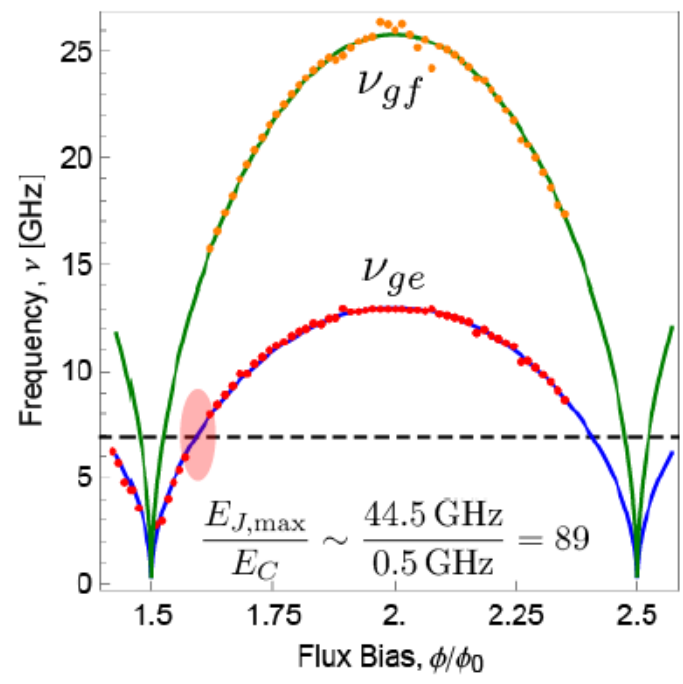

Measurement of charge dispersion on transmon qubits: follow well the expectation (doubling: Quasi-particle poisoning)

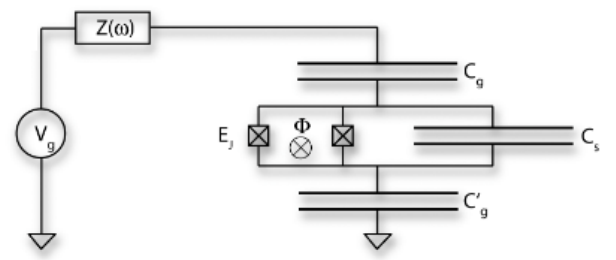

Charge and phase wave functions

$E_J/E_C = 0.01$

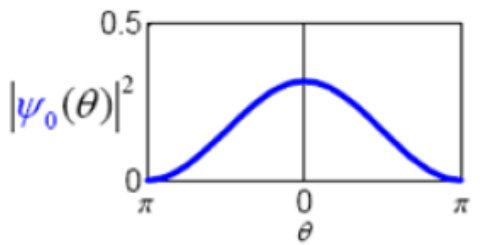
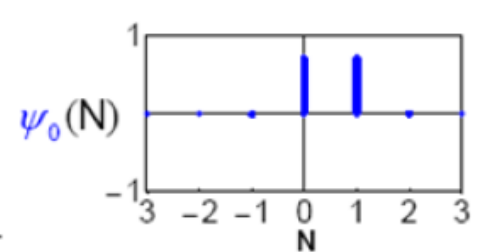
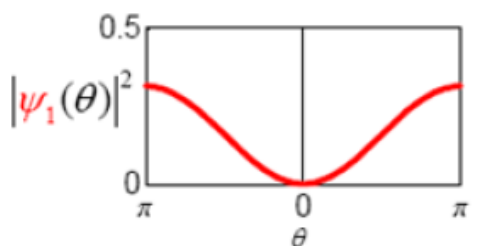
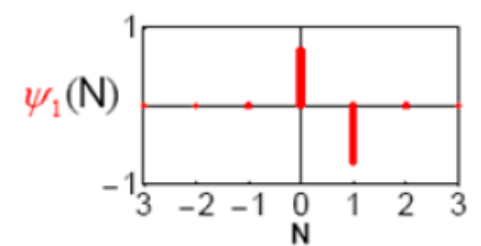
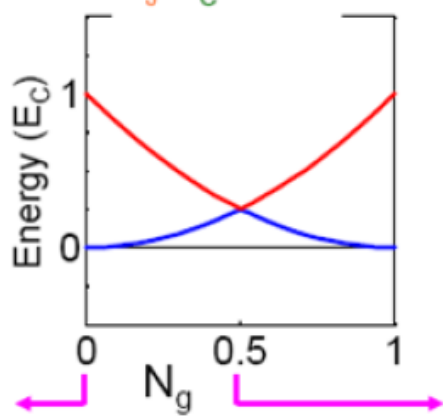
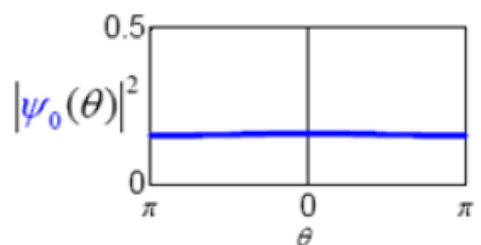
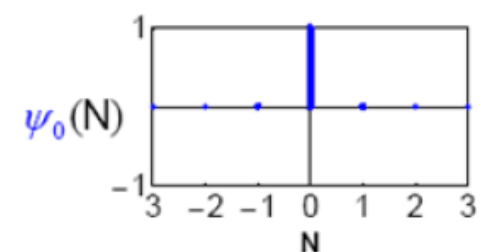
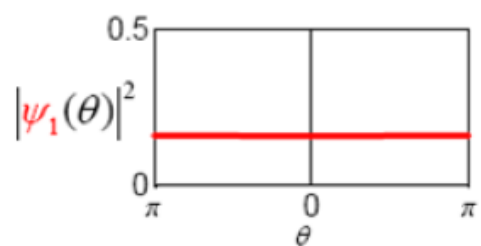
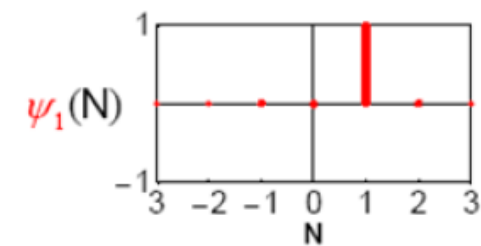

$$\begin{aligned}
 |\psi_1\rangle &\approx |N=1\rangle & |\psi_1\rangle &\approx \frac{|N=0\rangle - |N=1\rangle}{\sqrt{2}} \\
 |\psi_0\rangle &\approx |N=0\rangle & |\psi_0\rangle &\approx \frac{|N=0\rangle + |N=1\rangle}{\sqrt{2}}
 \end{aligned}$$

Charge and phase wave functions

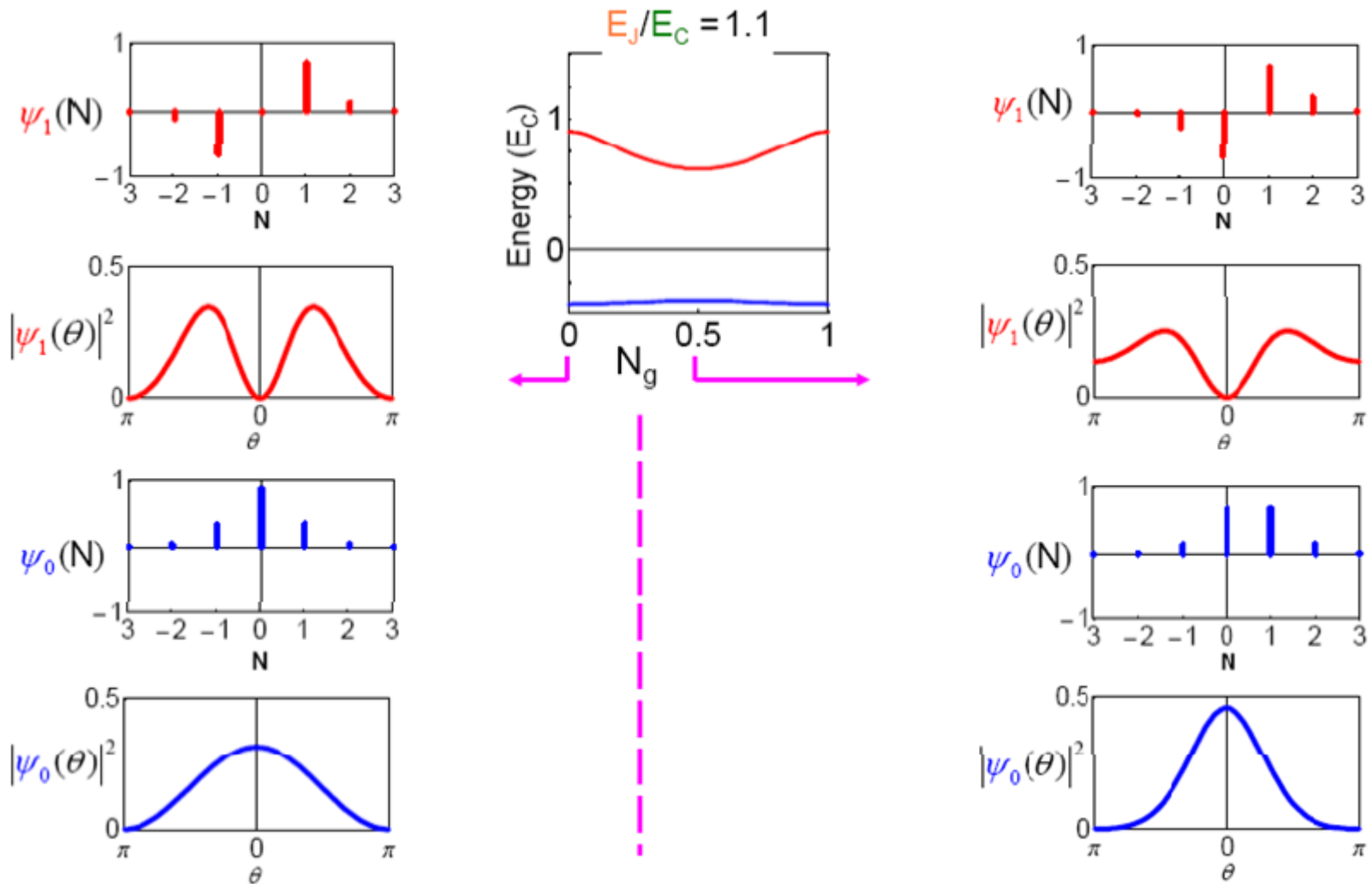

Transmon

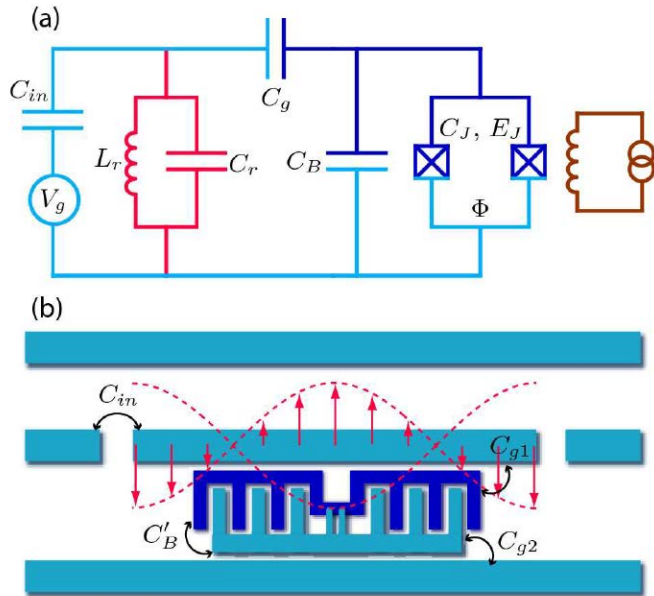

Cooper pair box + large shunt capacitor to decrease E_C
 Island volume ~ 1000 times bigger than conventional CPBs
 E_J flux tunable
 Readout – coupling to microwave resonator – RC circuit

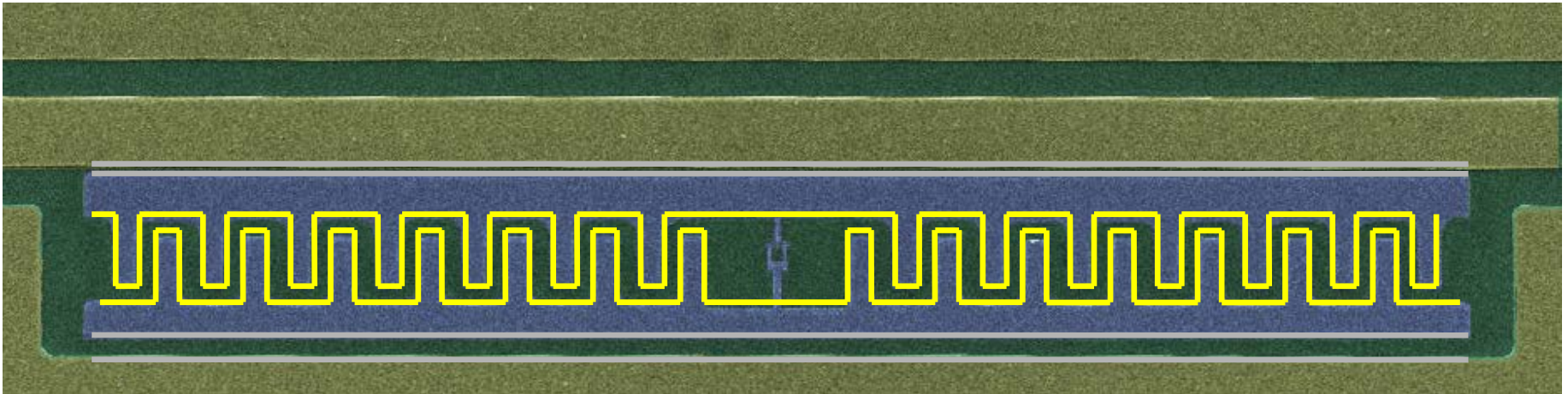
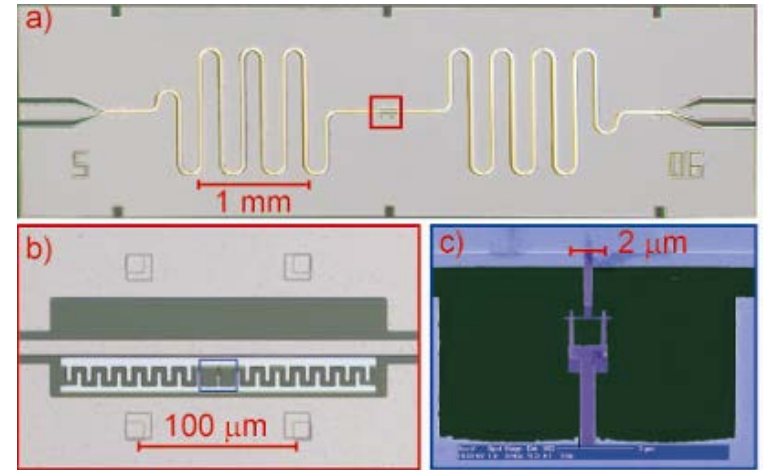

SC circuits

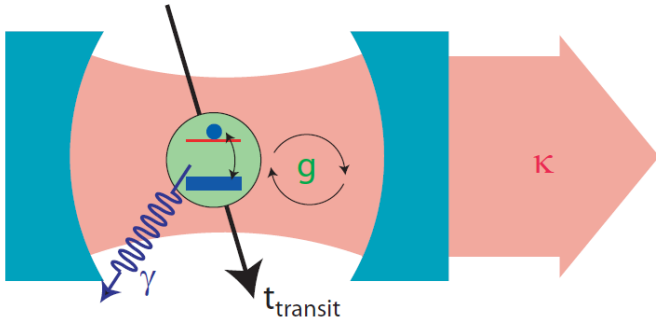

Fabry – Perot cavity for optics – using mirrors

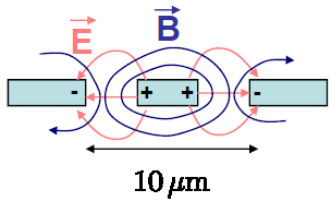

Central conductor and ground plane – essentially a coax

Superconducting circuit to minimize losses (white – SC material, black etched away)
 Capacitors: voltage antinodes – zero current – good for electrical dipole coupling
 Current antinode (voltage node) - maximal current – good for inductive coupling

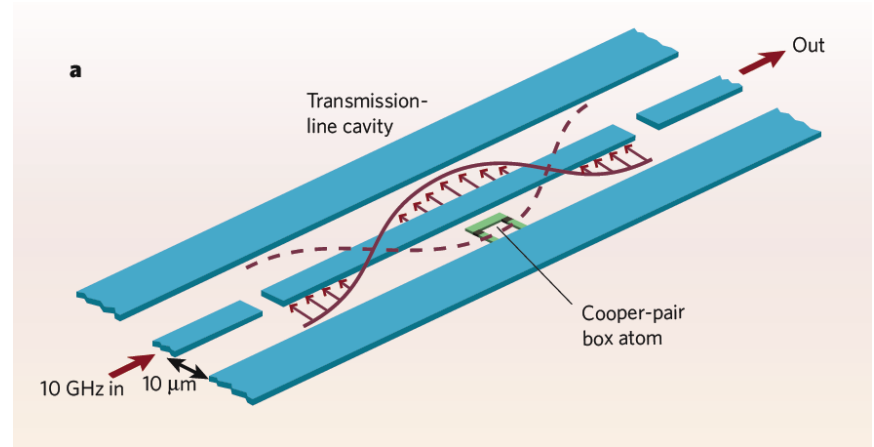

Fabry – Perot cavity for MW photons – capacitive mirrors

R.J. Schoelkopf et al., Nature 451, 664 (2009)
M. Göppl, : J. Appl. Phys. 104, 113904 (2008)

