

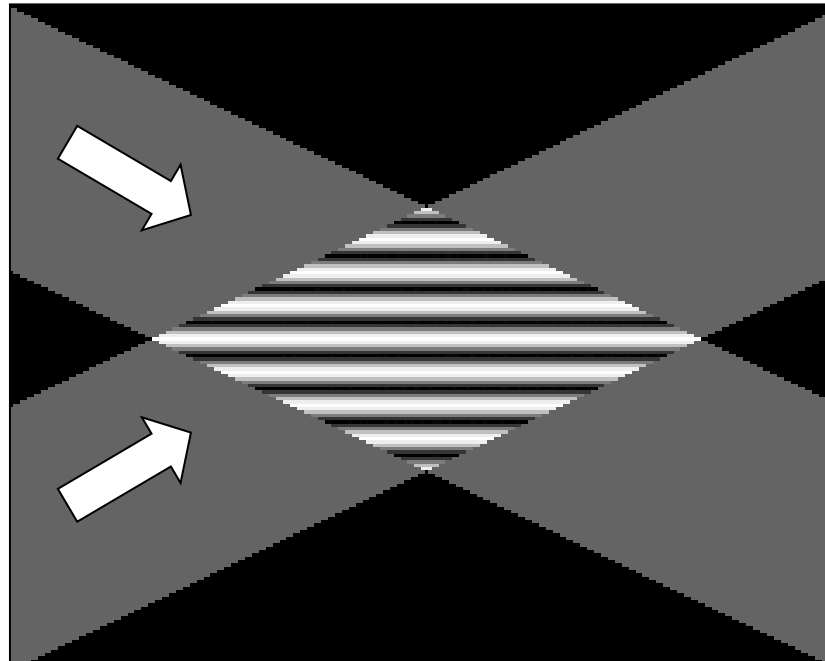

▪ Az interferencia fogalma ▪

Interferencia: az a jelenség, amikor két v. több diszkrét hullám fázishelyes szuperpozíciója során a térben állóhullám kép alakul ki, ami elektromágneses hullámok esetén (általában) világos-sötét interferencia csíkok formájában figyelhető meg.



Két síkhullám
interferenciája



▪ Interferencia példák (kéthullám) ▪

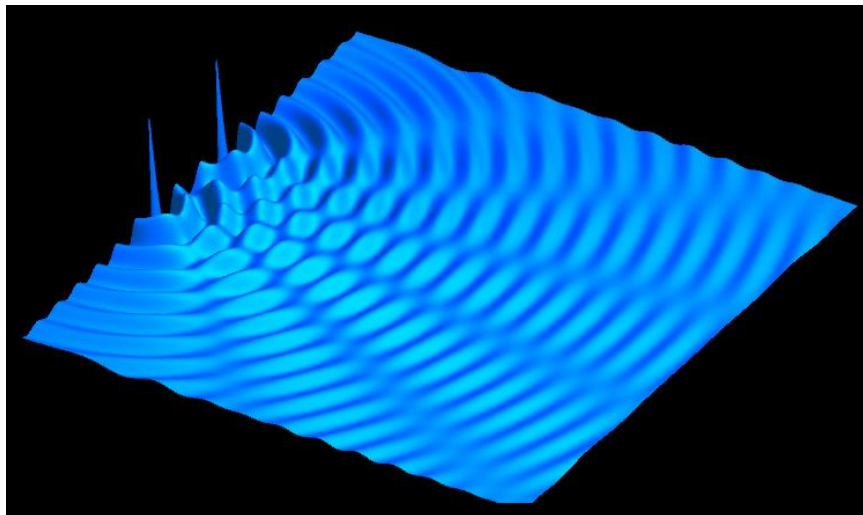

Két pontforrás (hullámkép pl. vízfelszínen)

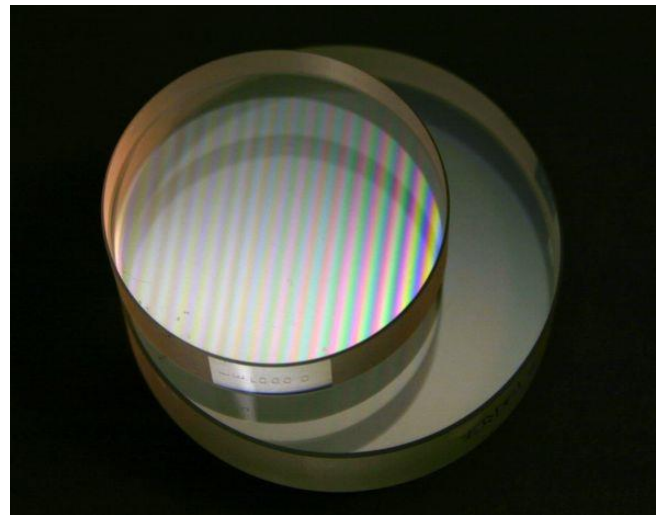

Newton-gyűrűk (itt vonalak)

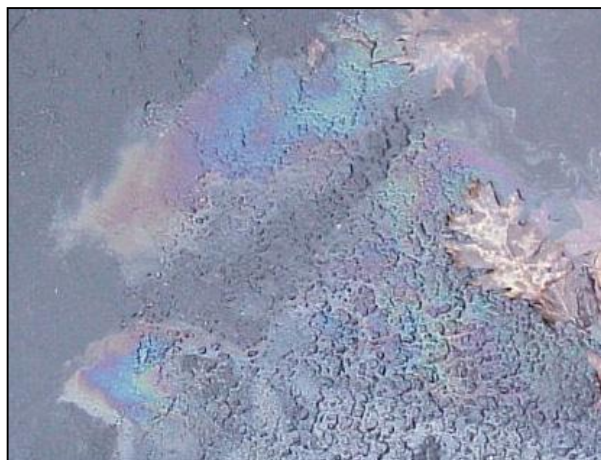

Olajfolt

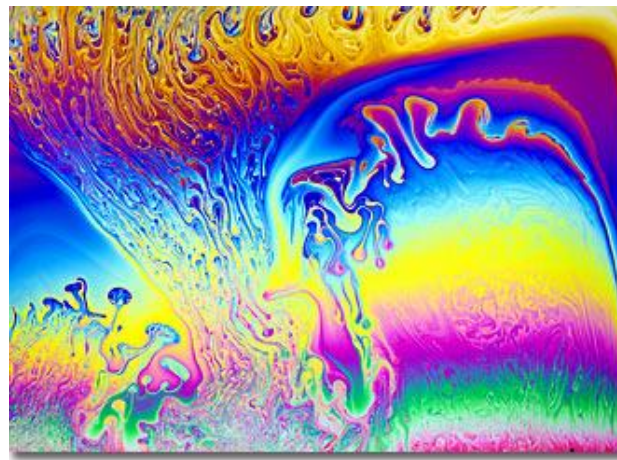

Szappanbuborék



Hullámfront-osztó interferométerek

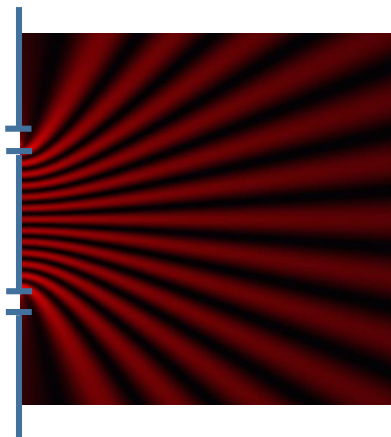

Young-féle kétréses interferométer

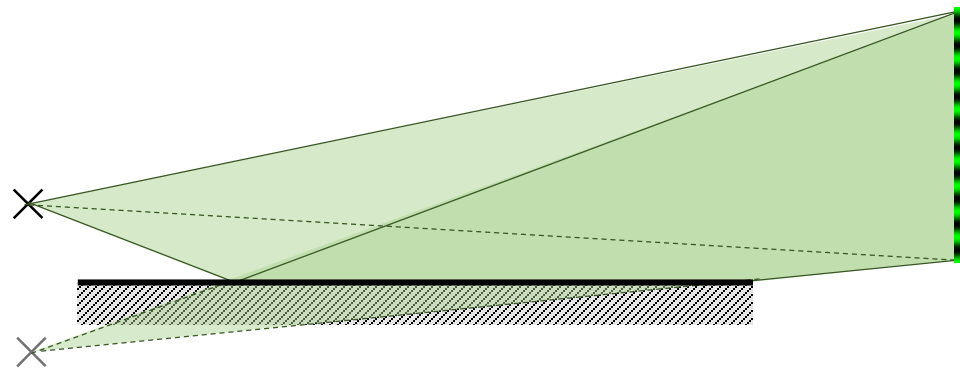

Lloyd-tükör

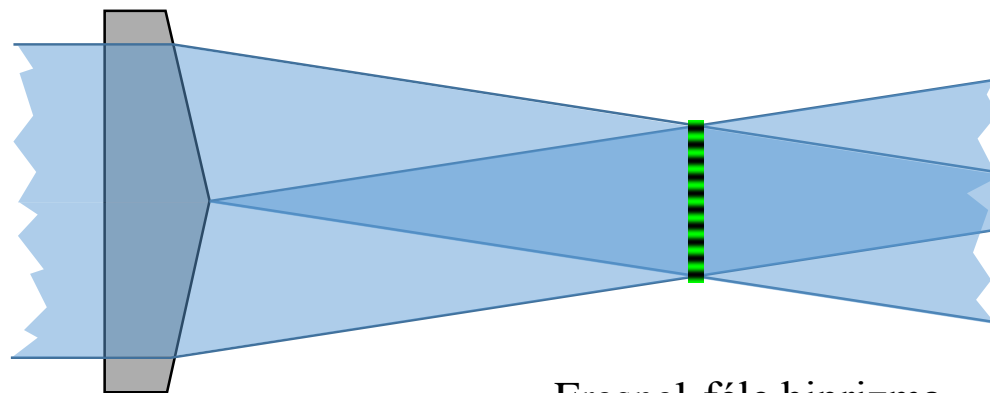

Fresnel-féle biprizma



Amplitudó-osztó interferométerek

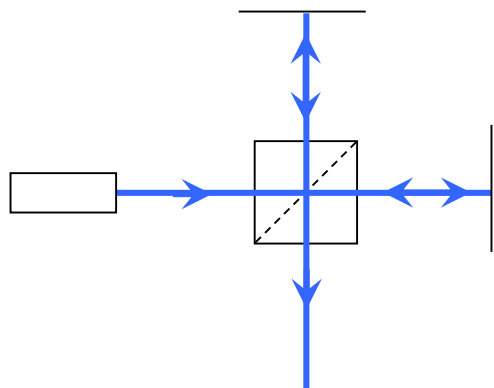

Michelson (Twyman-Green)

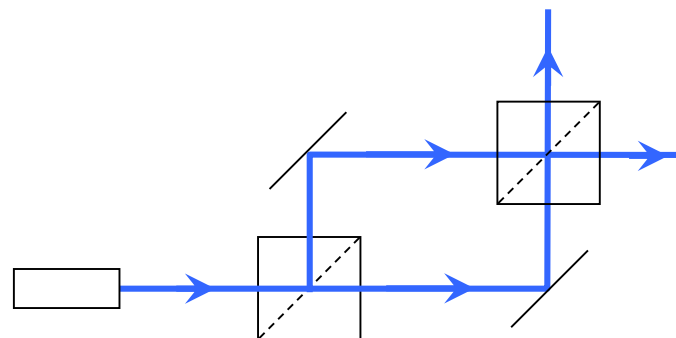

Mach-Zehnder

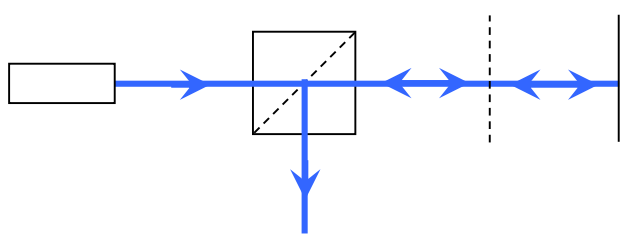

Fizeau

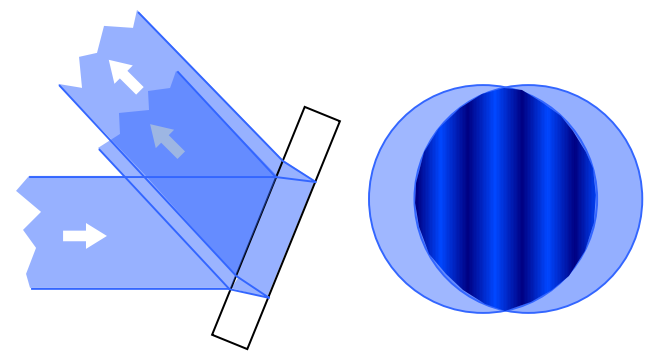

Nyíró (shearing)



▪ Hová lesz a fény ? ▪

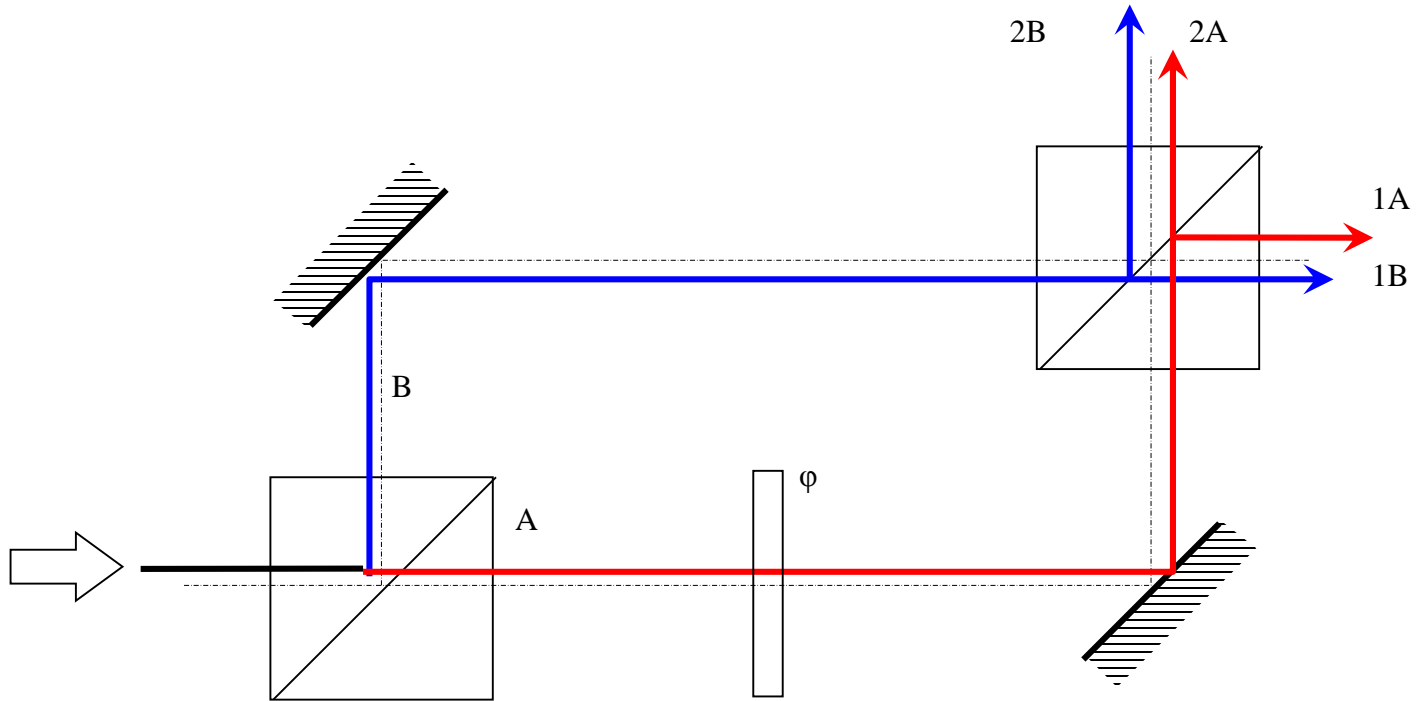



▪ Interferencia példák (többhullám) ▪



Tükrözésgátló (AR) bevonat



Diffrakciós rács (CD)



▪ Többhullám interferencia ▪

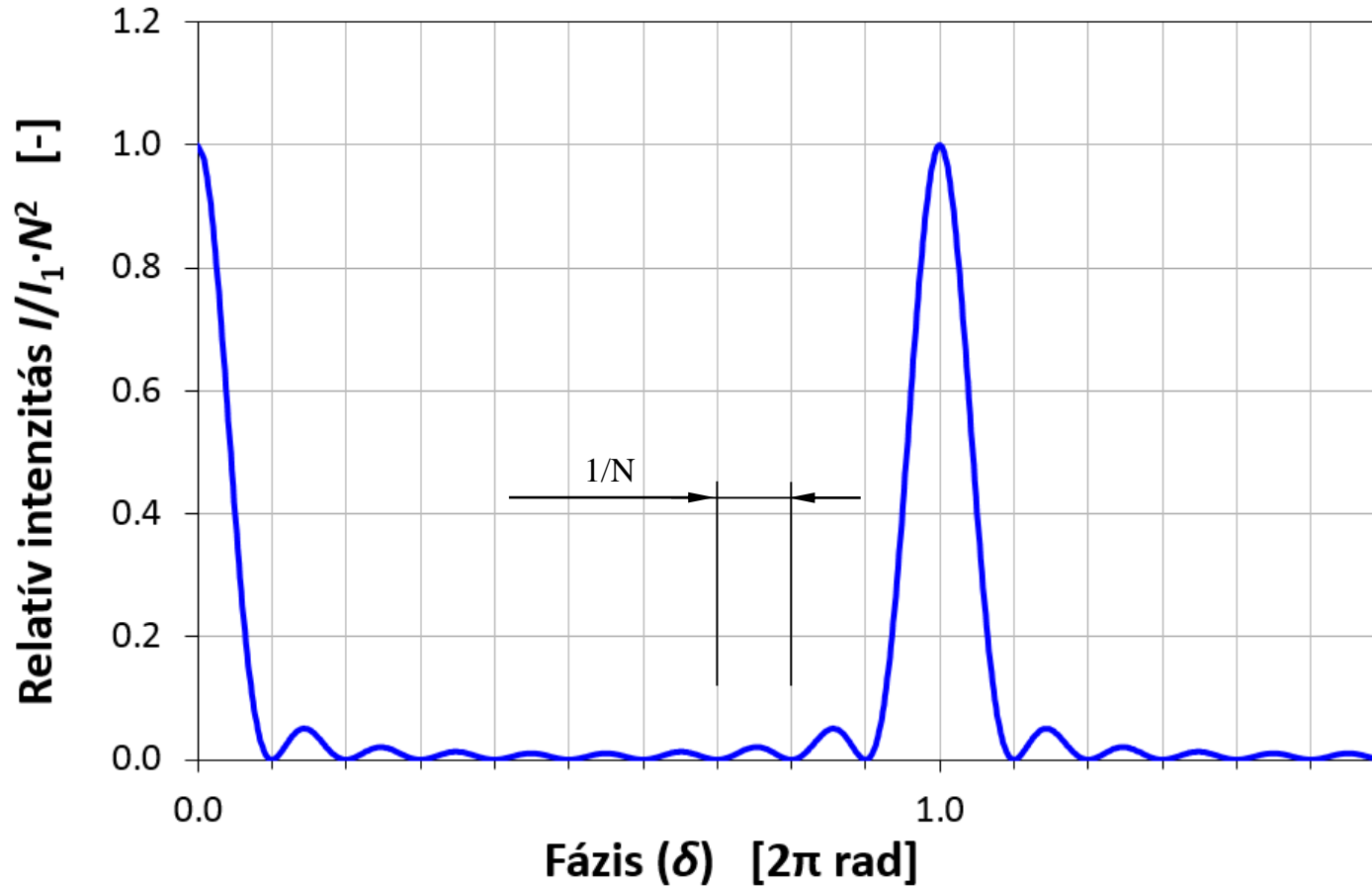



▪ Diffrakciós rács felbontása ▪

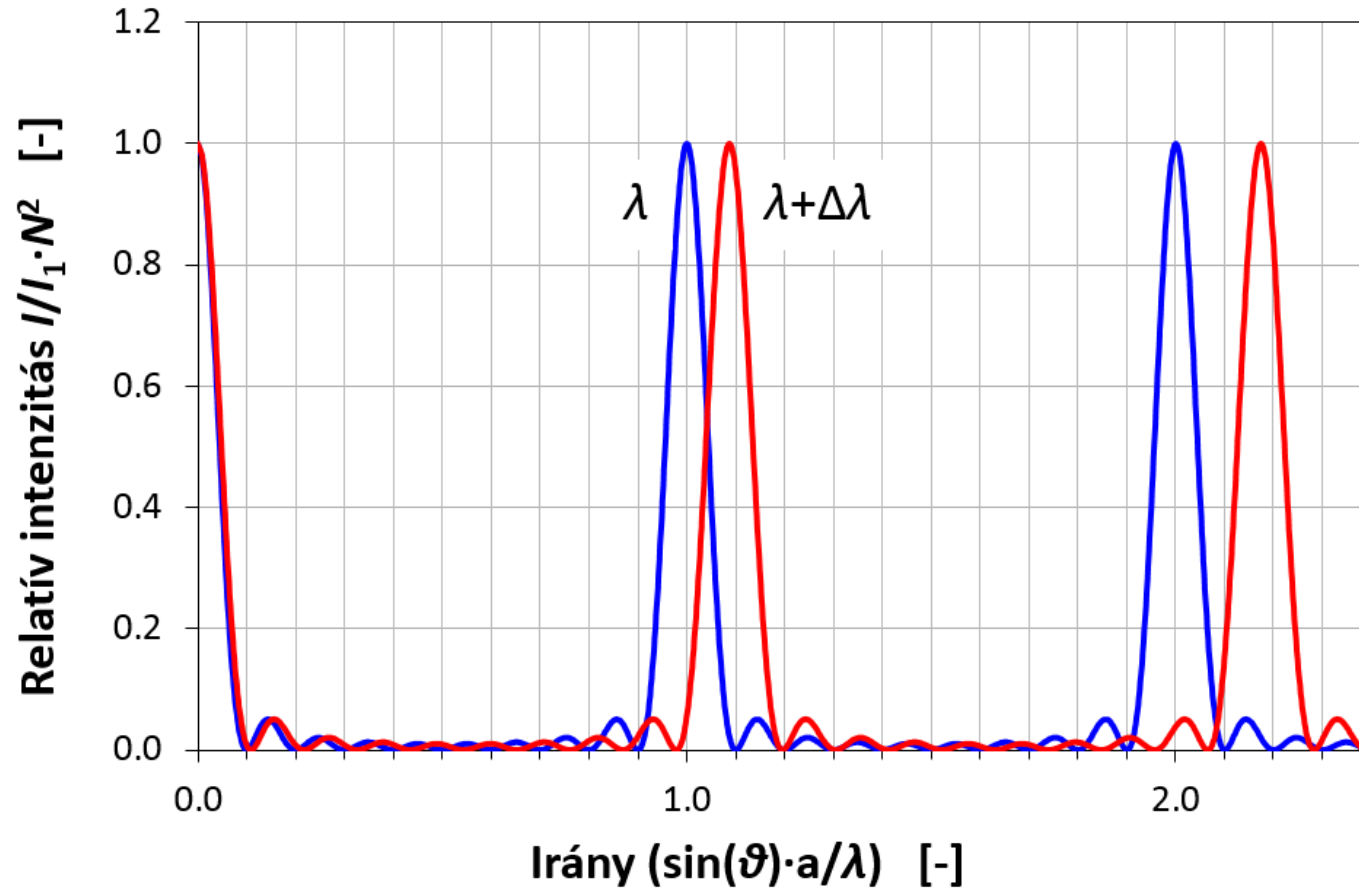

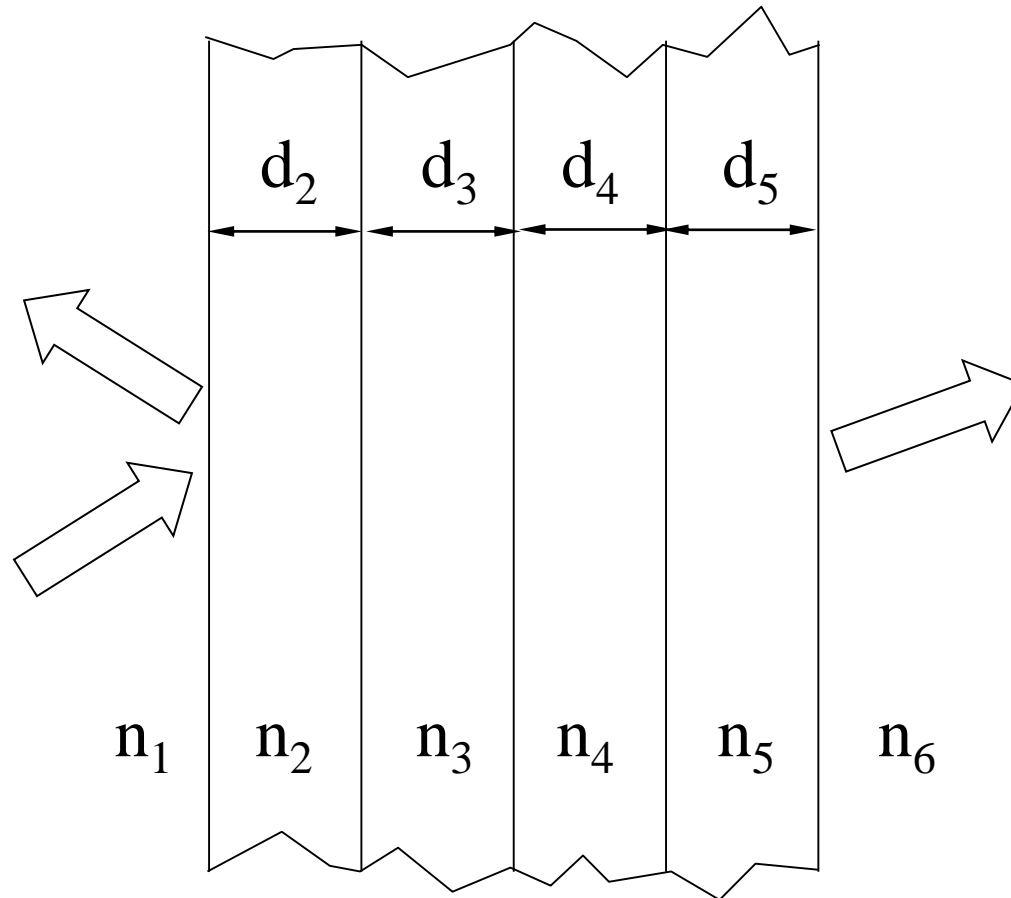

(Fizikai optika tárgy)