



## ▪ A geometriai optika előnye ▪

**Vektor diffrakció:** Maxwell-egyenletek megoldása (véges elem módszerrel)

**Skalár diffrakció:** Fresnel-Kirchhoff-diffrakció (önmagában ritkán alkalmazzák)



Fresnel-közelítés:  $\sim 10^8$  mintavételi pont

Fraunhofer-közelítés:  $\sim 10^4$  mintavételi pont

Geometriai optika:  $\sim 10^2$  mintavételi pont

( $\sim 100.000$  metszéspont/sec)

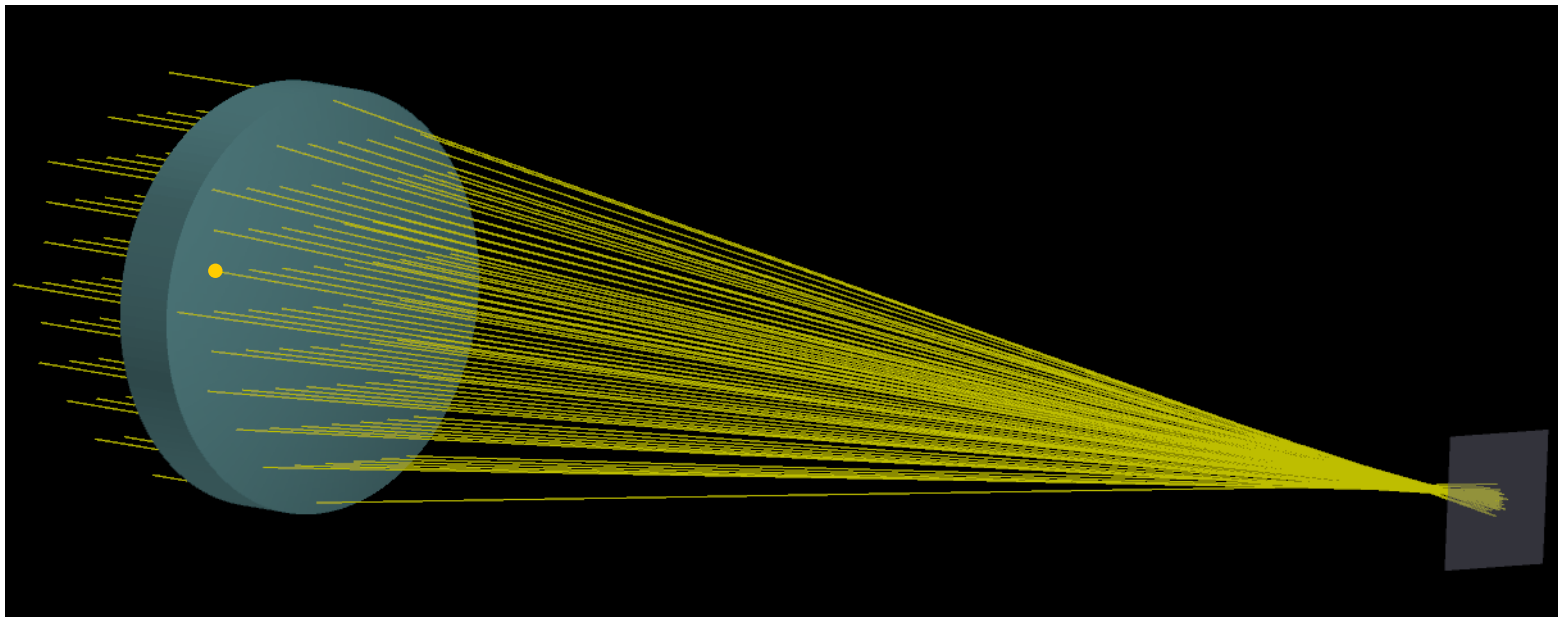

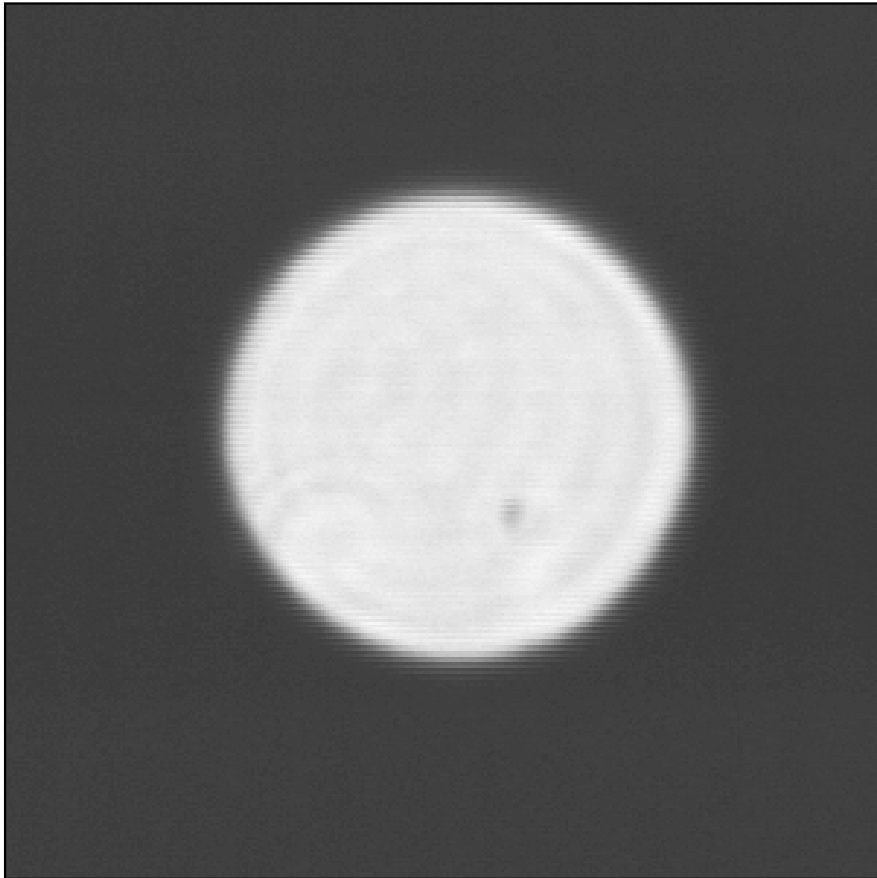

Geometriai optikai árnyék

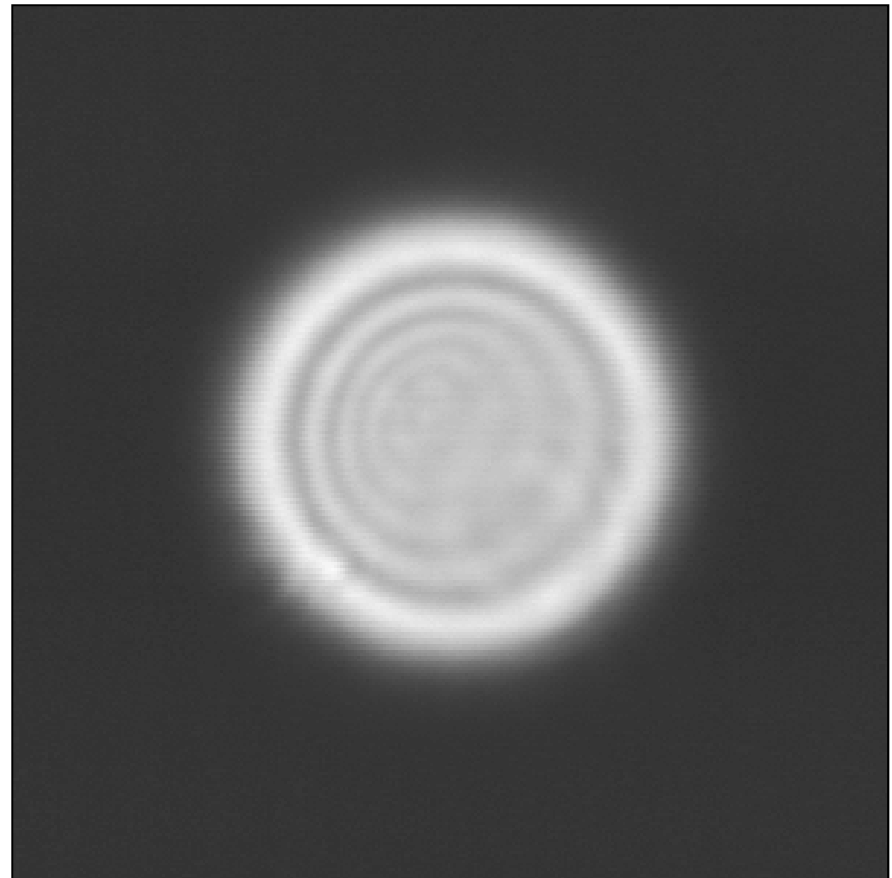

Fresnel-diffrakció

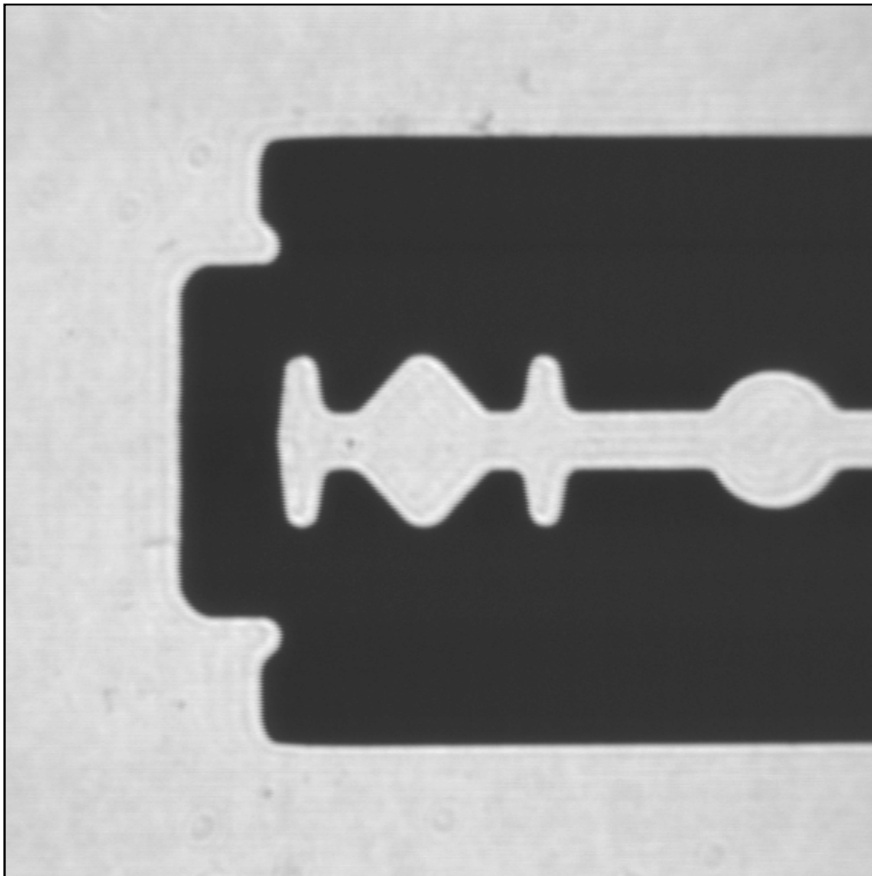

Geometriai optikai árnyék

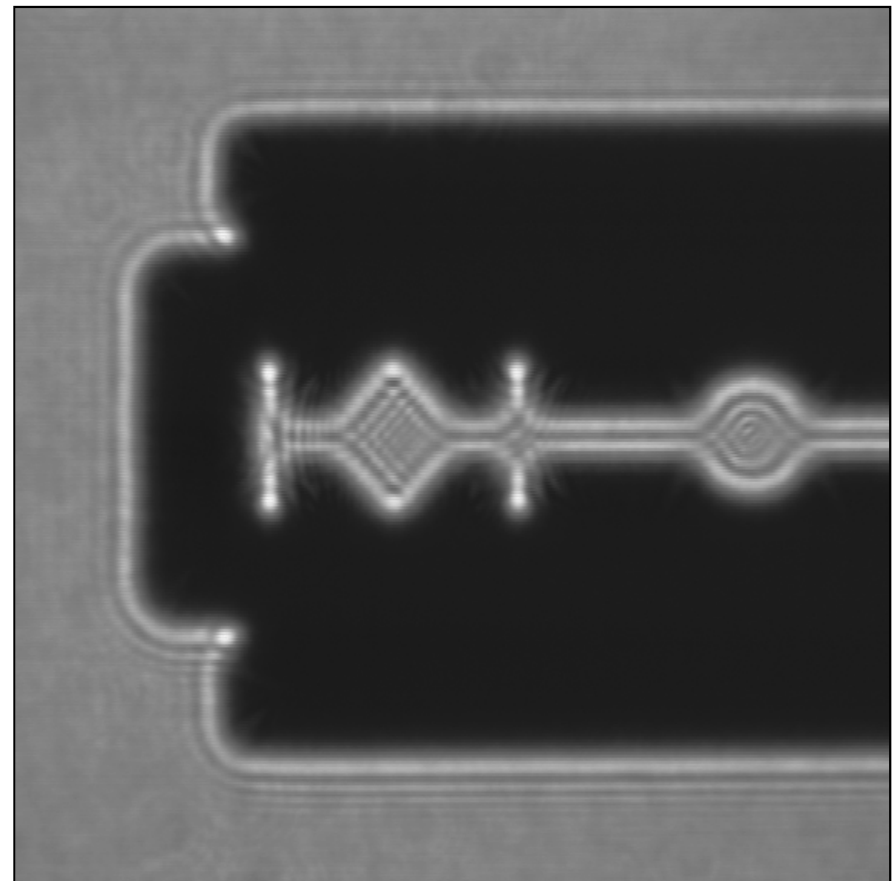

Fresnel-diffrakció

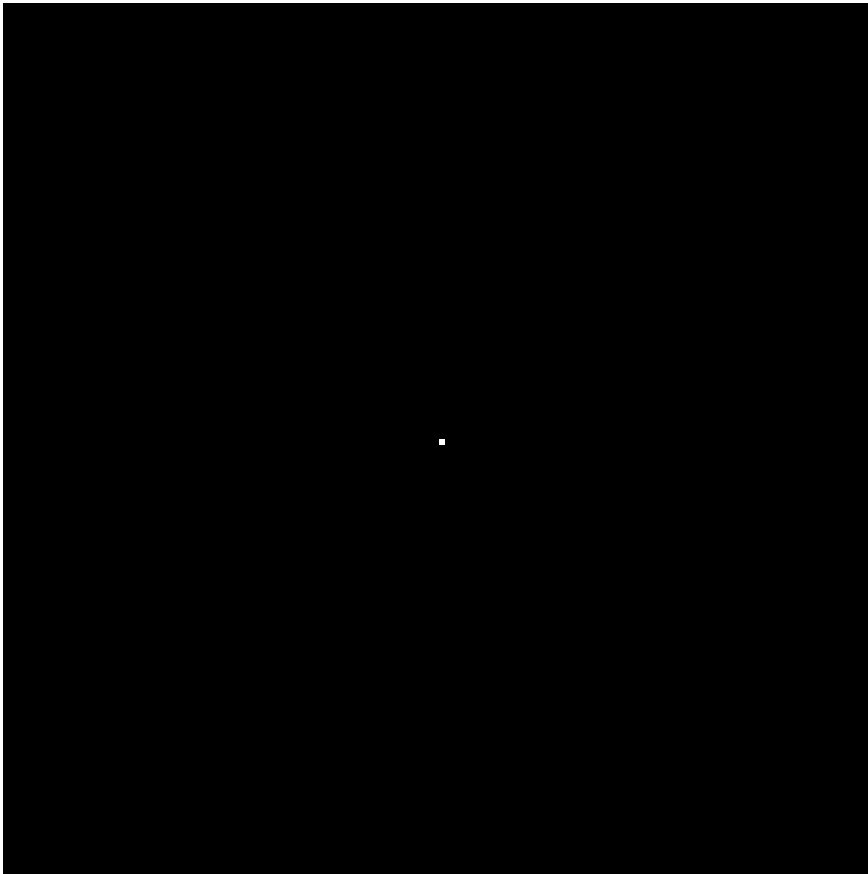

Geometriai optikai kép

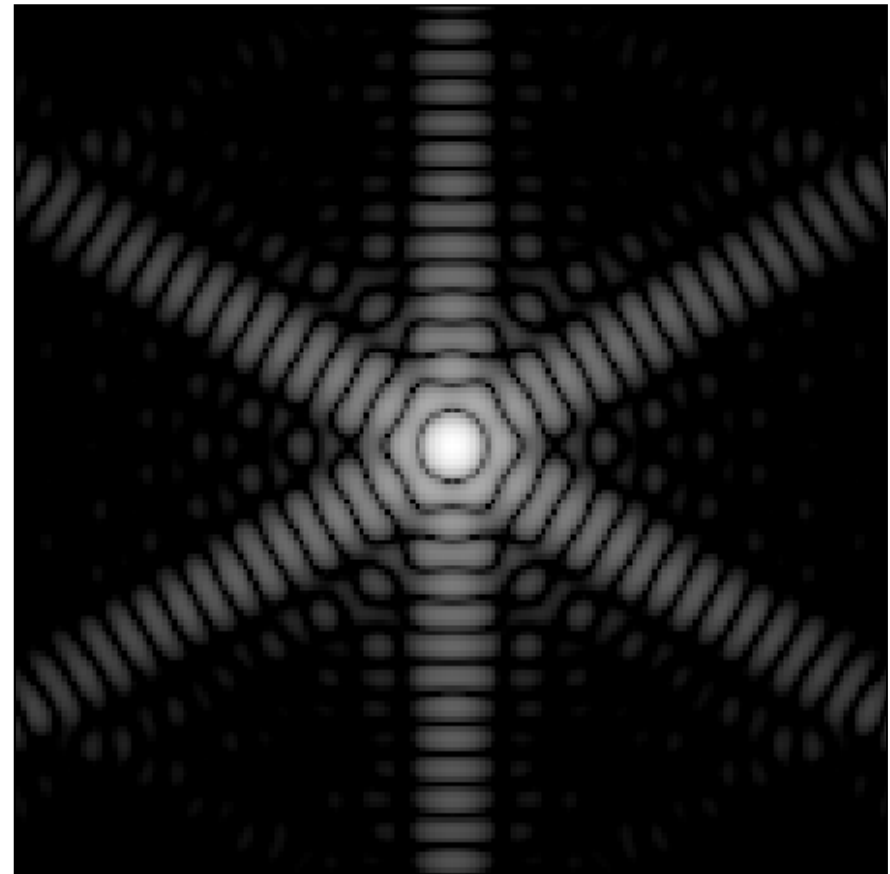

Fraunhofer-diffrakciós kép

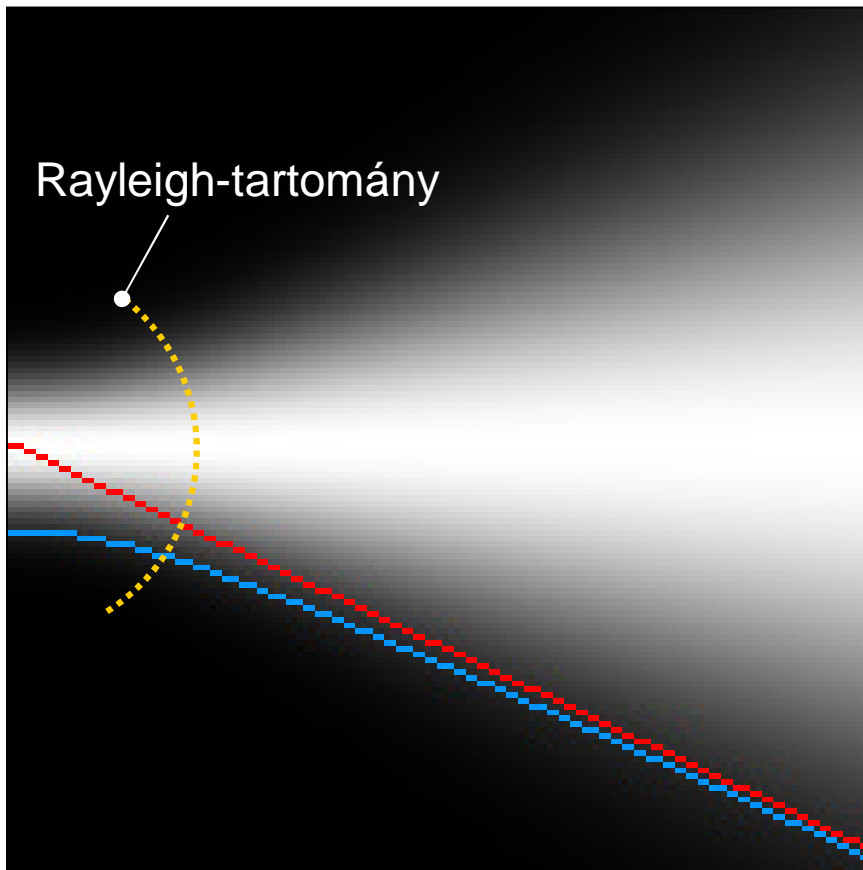

Gauss-nyaláb terjedése

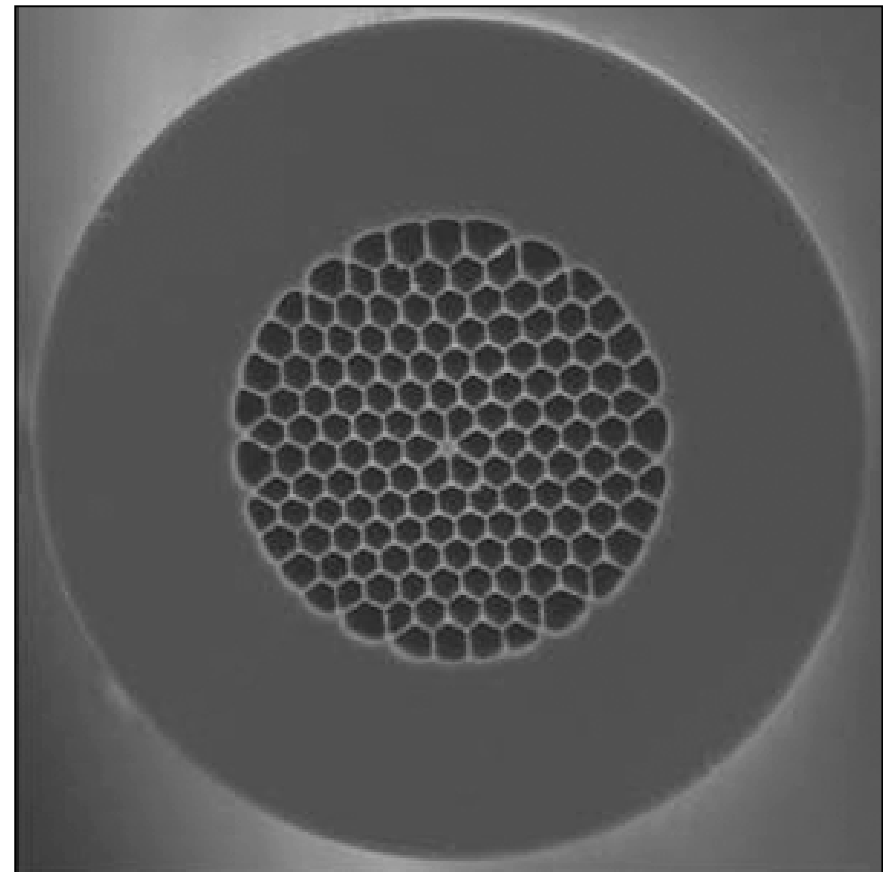

Fotonikai kristály



# ▪ Fényeloszlás fókuszfolt környezetében ▪

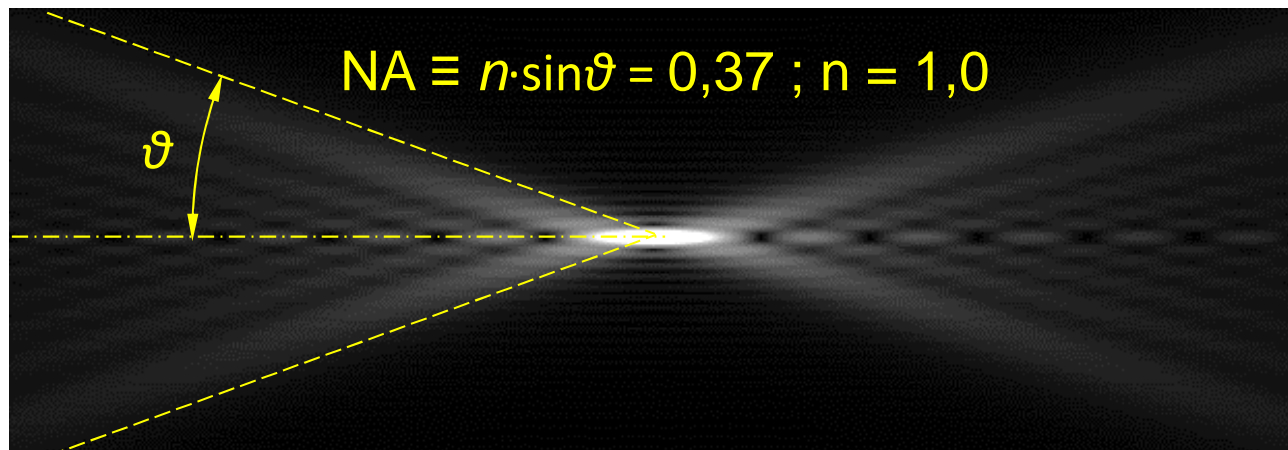

$\lambda = 1,0 \mu\text{m}$

Fókuszált nyaláb  
intenzitáseloszlása

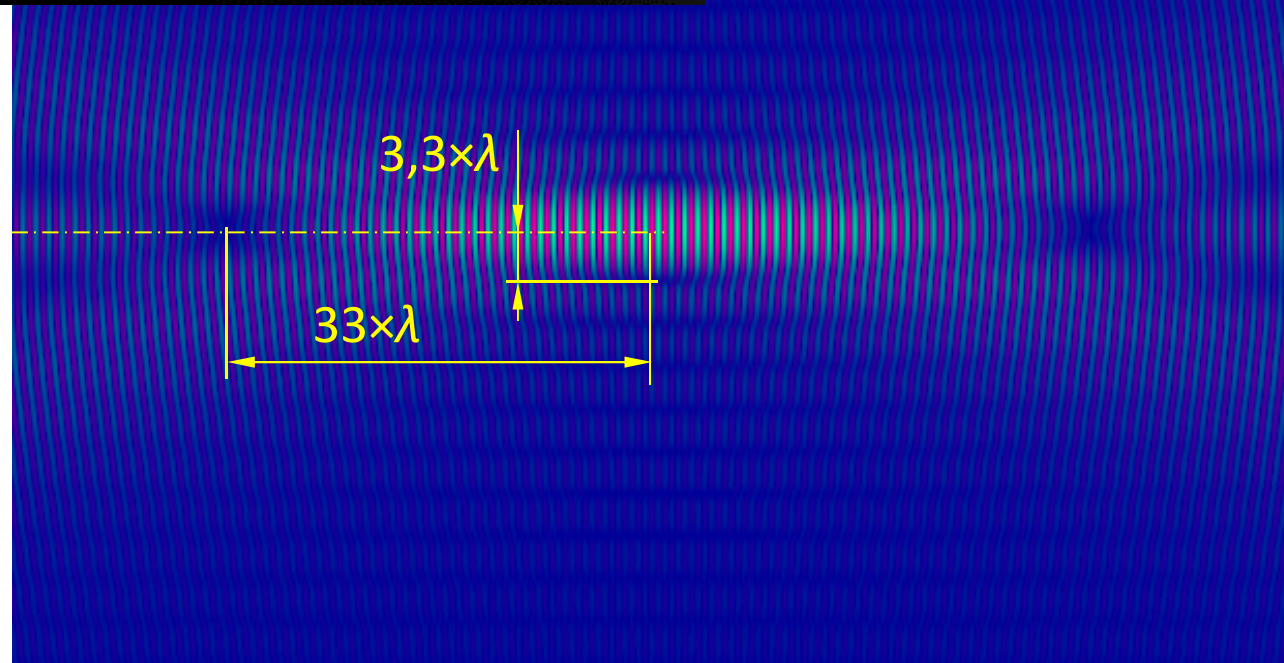

Fázisváltozások a fókuszfolt környezetében



Lassan változó  
amplitúdójú közelítés

$$\frac{|\text{grad}(E_{0x})|}{E_{0x}} \ll k_0 \cdot |\text{grad}(S)|$$

$\Rightarrow$

Lokális hullámhossz  
és hullámszámvektor

$$\mathbf{k}_{lok} = k_0 \cdot \text{grad}(S)$$

$\Rightarrow$

$$\frac{|\text{grad}(E_{0x})| \cdot \lambda}{E_{0x}} \ll 2\pi$$

$\Downarrow$

$\nearrow$

Fázisviszonyokat  $E_{0x}$   
ne befolyásolja

$$|\nabla^2 E_{0x}| \ll k_{lok}^2 \cdot E_{0x}$$

$\Rightarrow$

$$|\nabla S| = n$$

$\Rightarrow$

$$k_{lok} = k_0 \cdot n$$
$$\lambda_{lok} = \lambda = \frac{\lambda_0}{n}$$

$\Rightarrow$

$$\frac{|\nabla^2 E_{0x}| \cdot \lambda^2}{E_{0x}} \ll 4\pi^2$$

Nulla hullámhosszúságú  
közelítés: geometriai optika





# Az intenzitástörvény szemléltetése

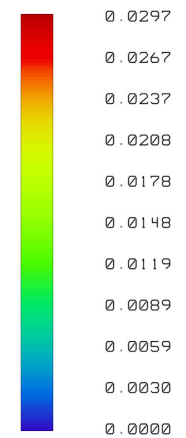
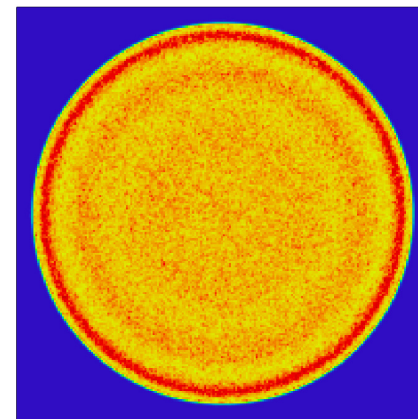
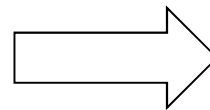
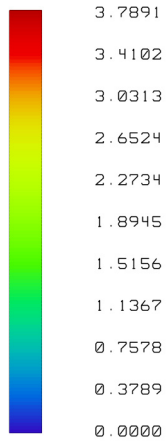
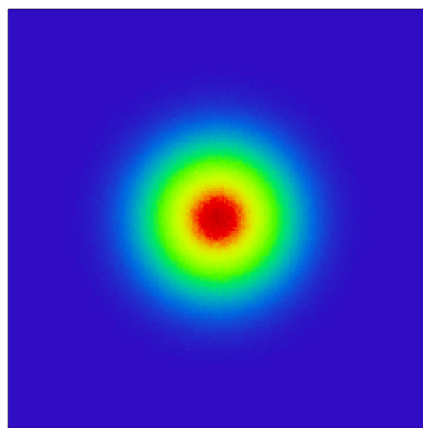
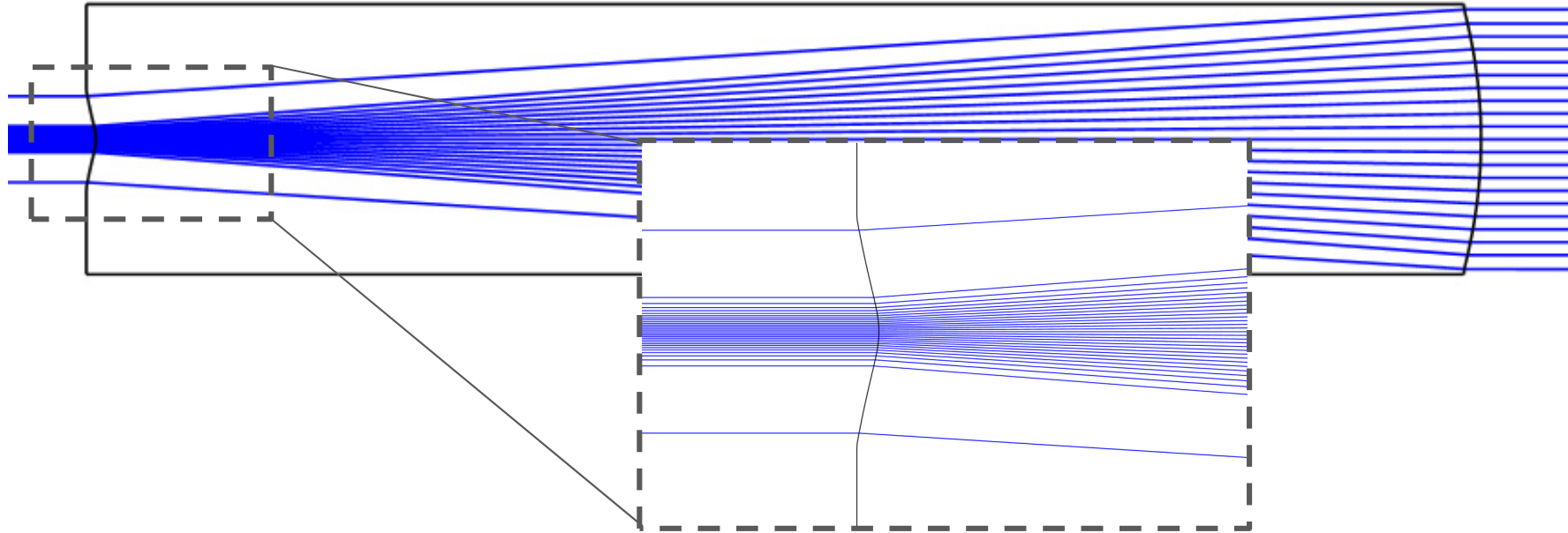





# ▪ A geometriai optika alkalmazásai ▪

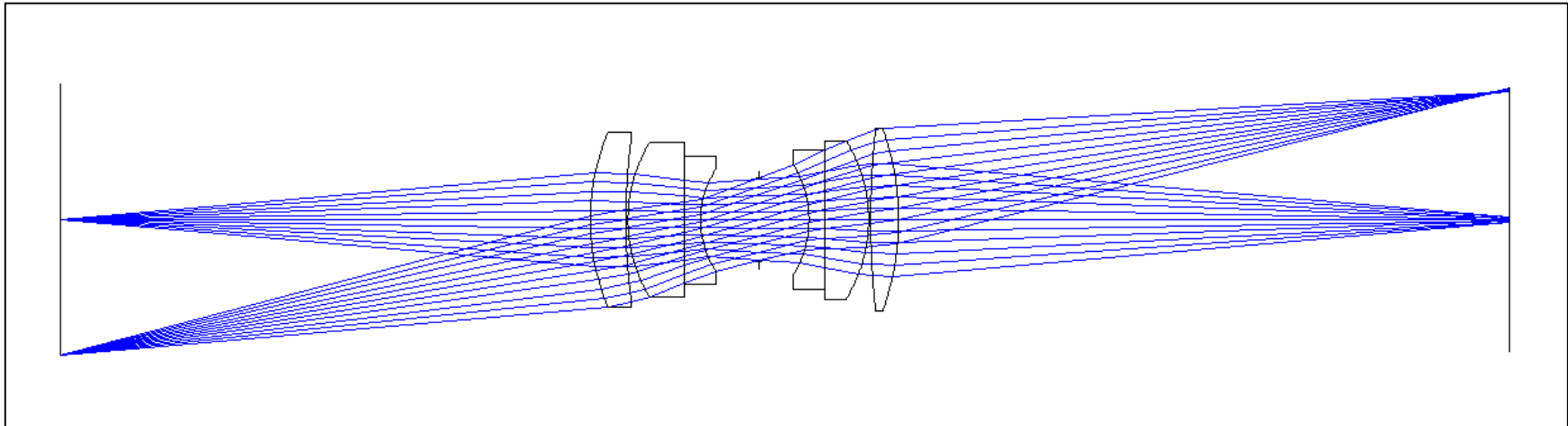

leképező rendszerek

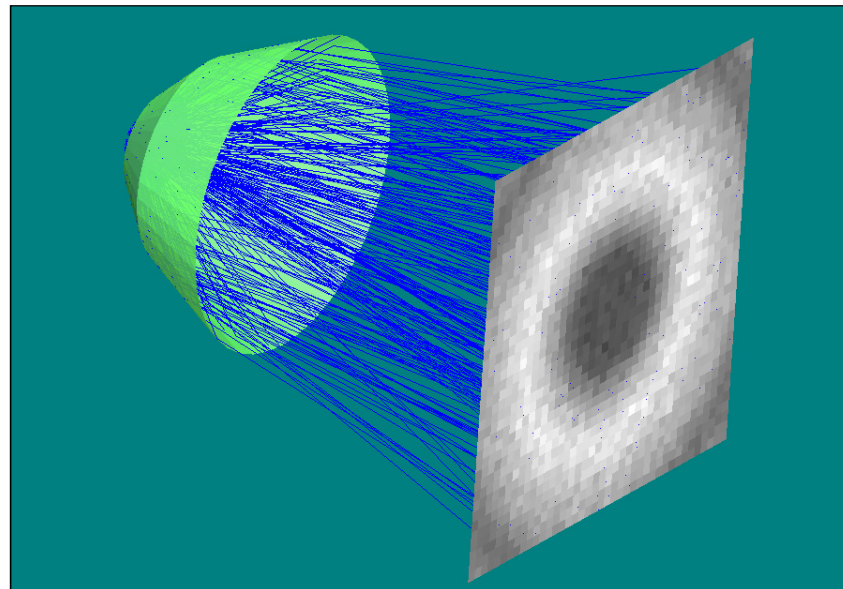

megvilágító rendszerek

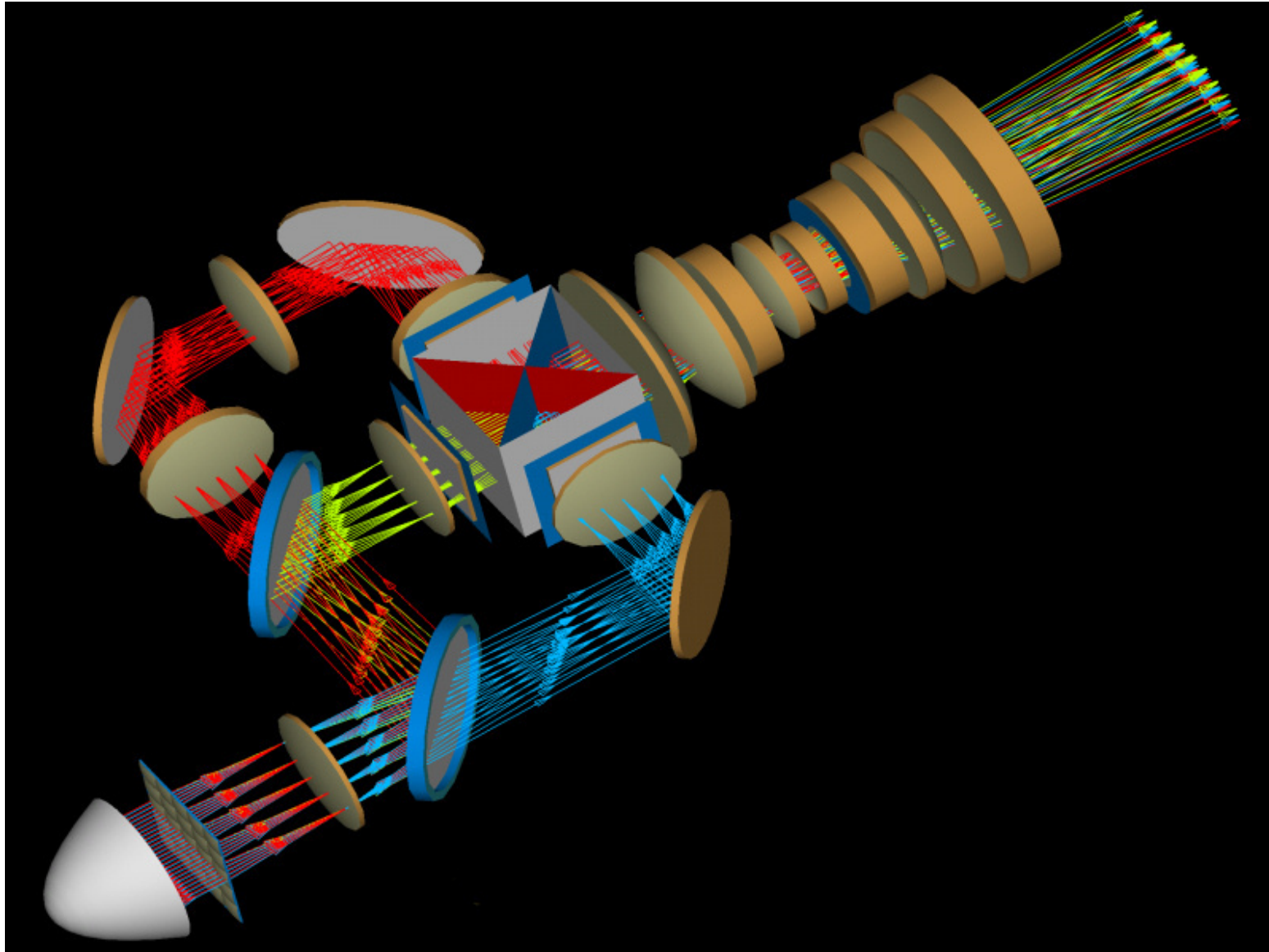



▪ Nagylátószögű objektív (210°) ▪

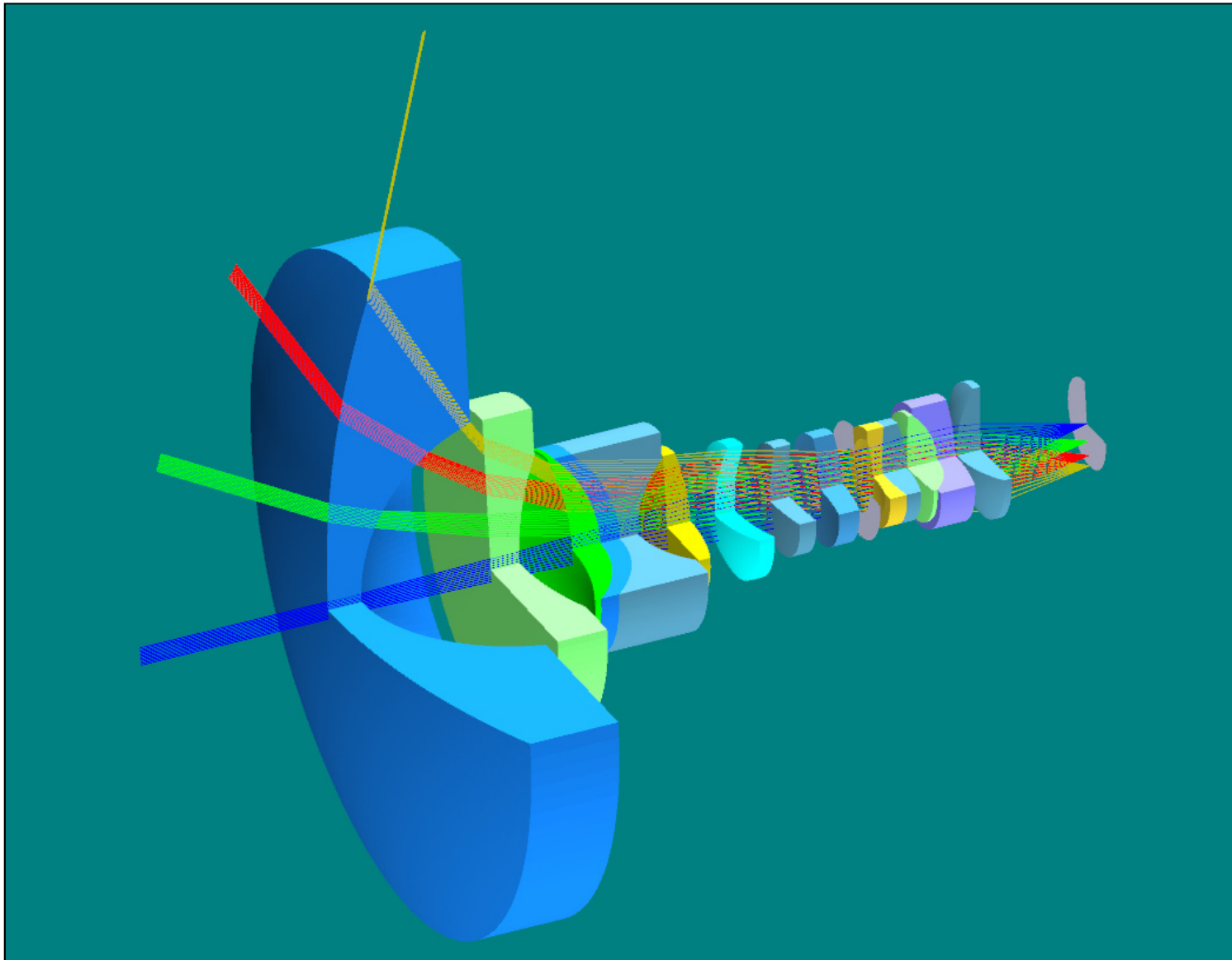

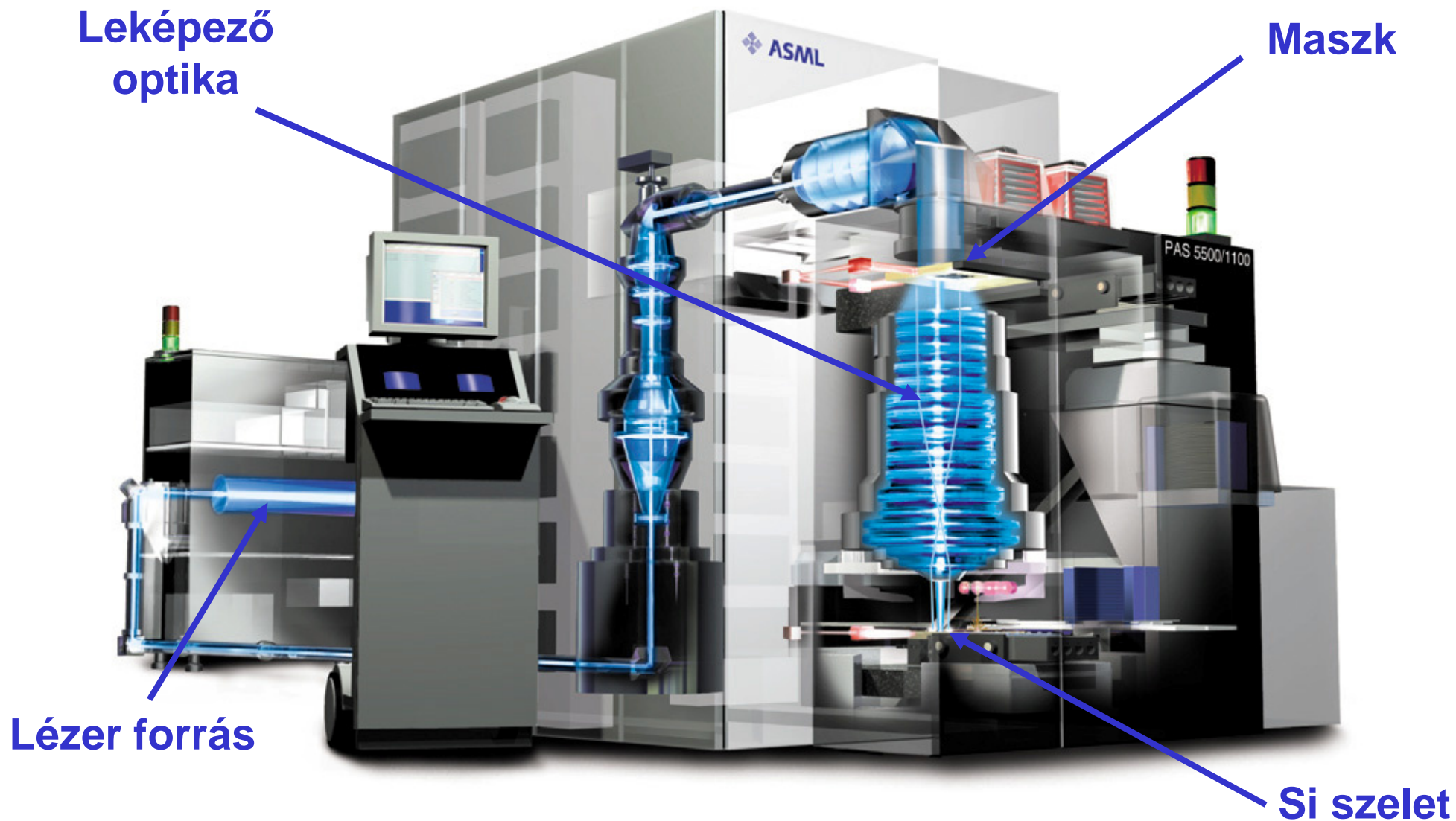



# ▪ 193 nm litográfia ▪



## Zeiss Starlith™ 900

$$m = -1/4 \times$$

NA 0,63

képtér 22 × 22 mm

vonalszélesség < 100 nm



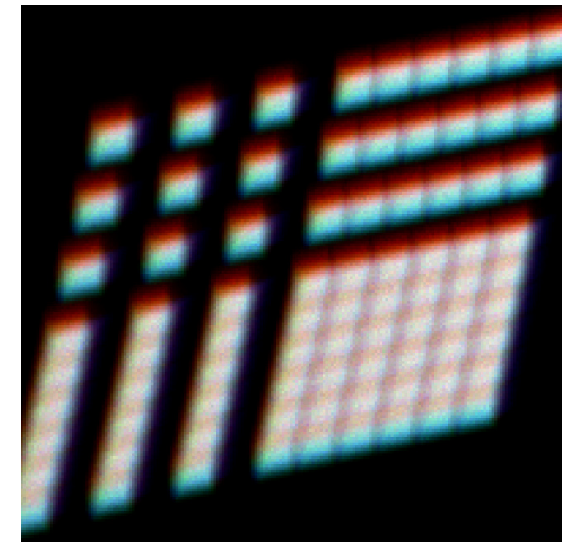
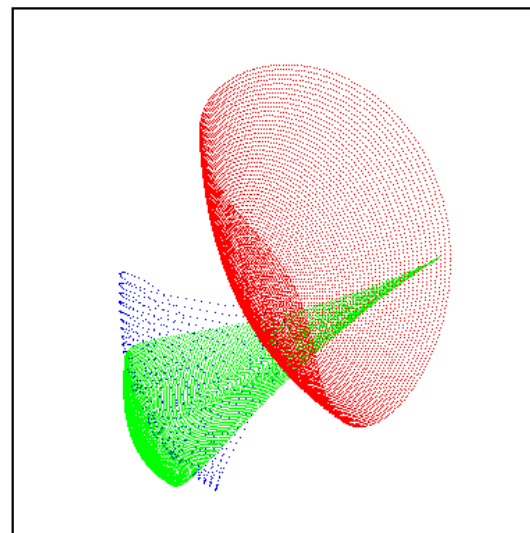
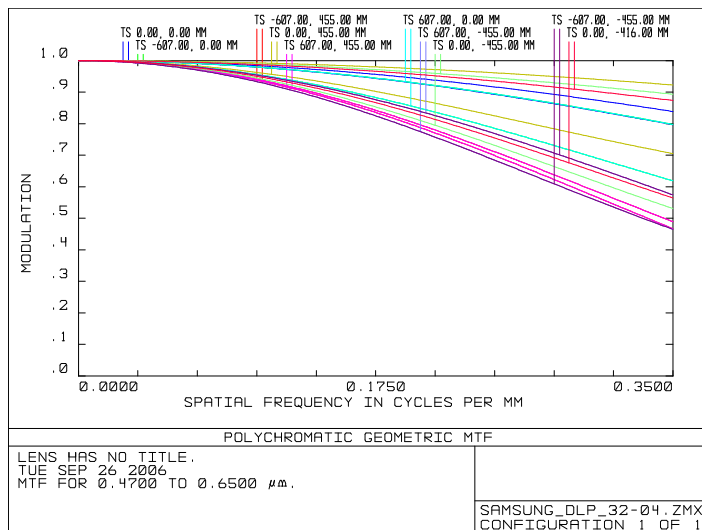
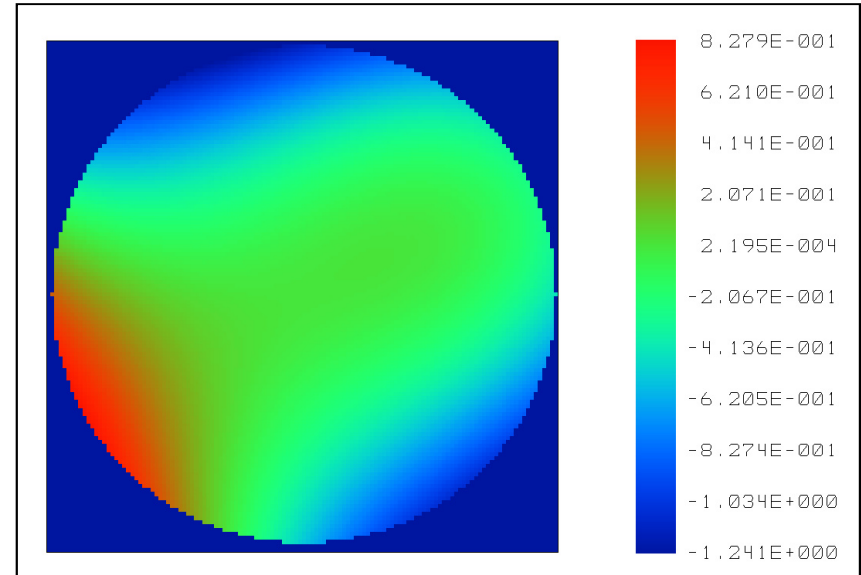
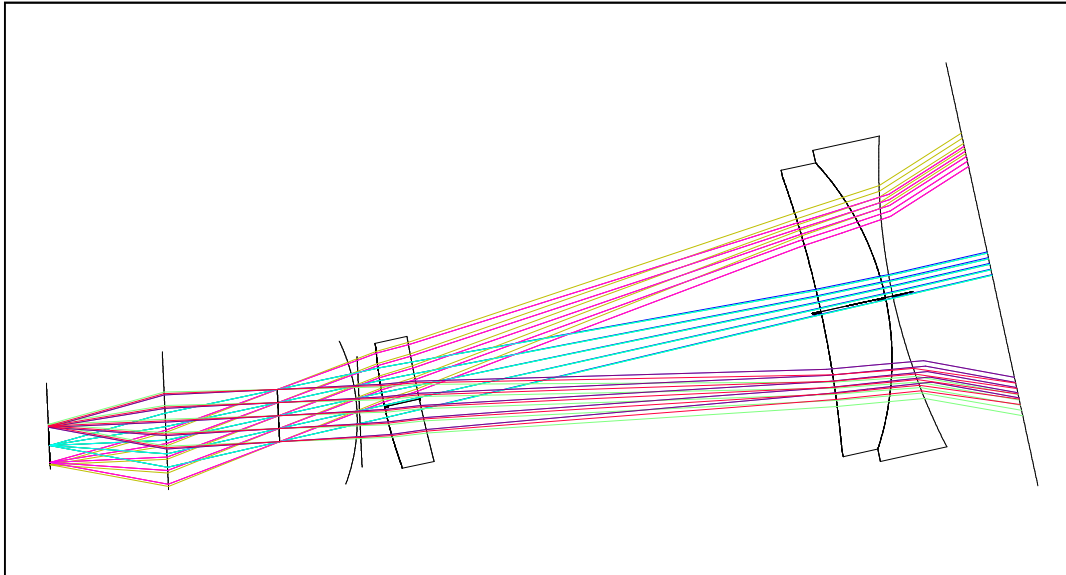

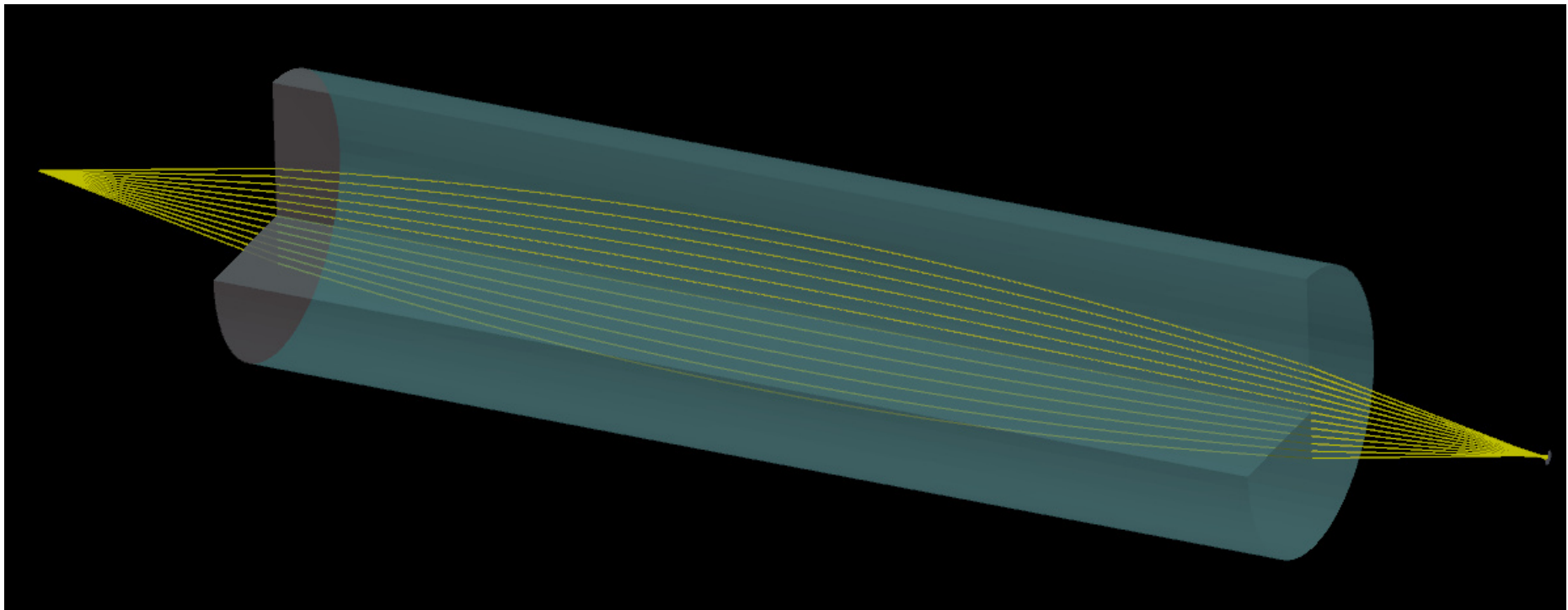

SELFOC lencse





# ▪ Telefon billentyűzet világítás ▪

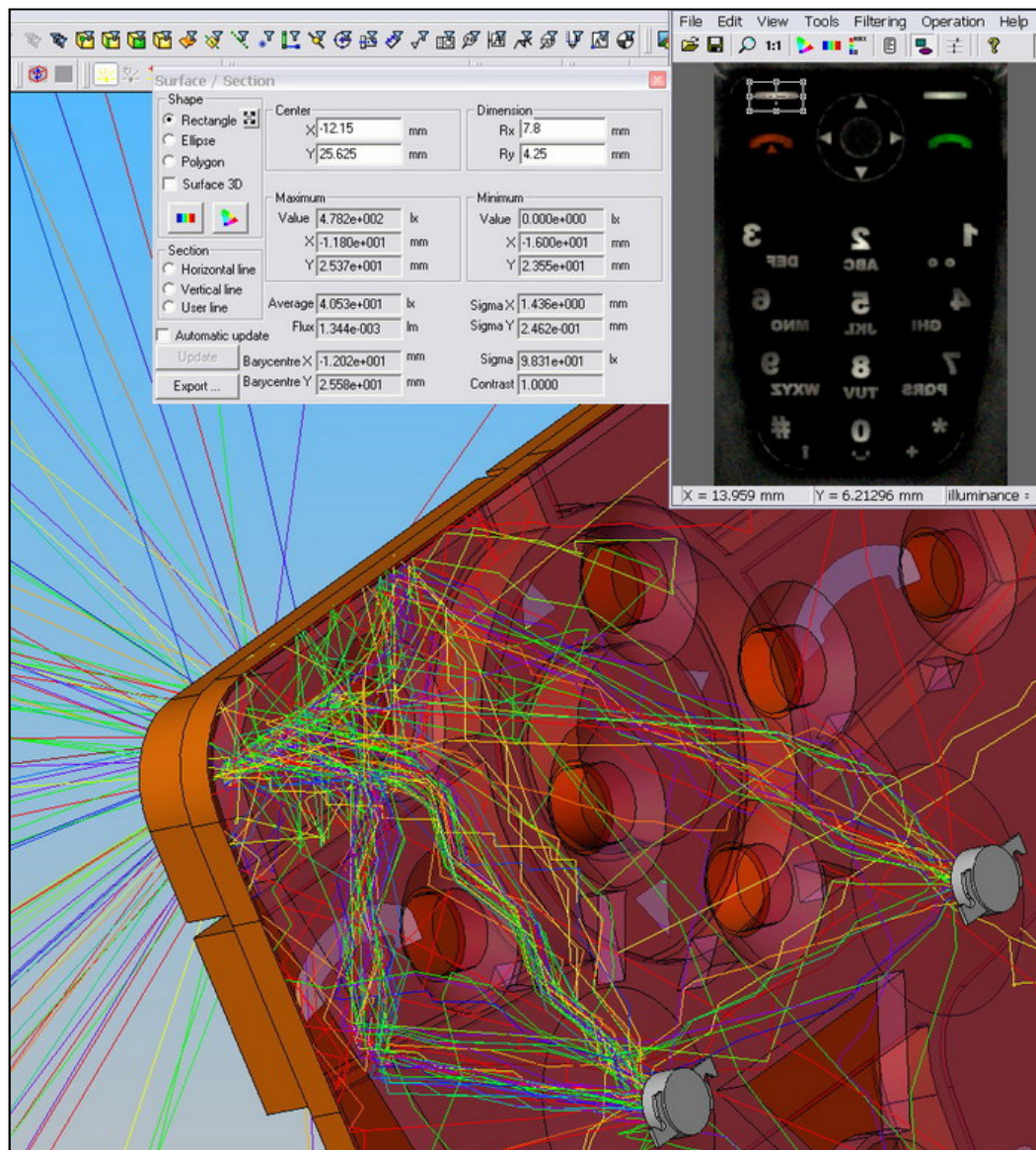

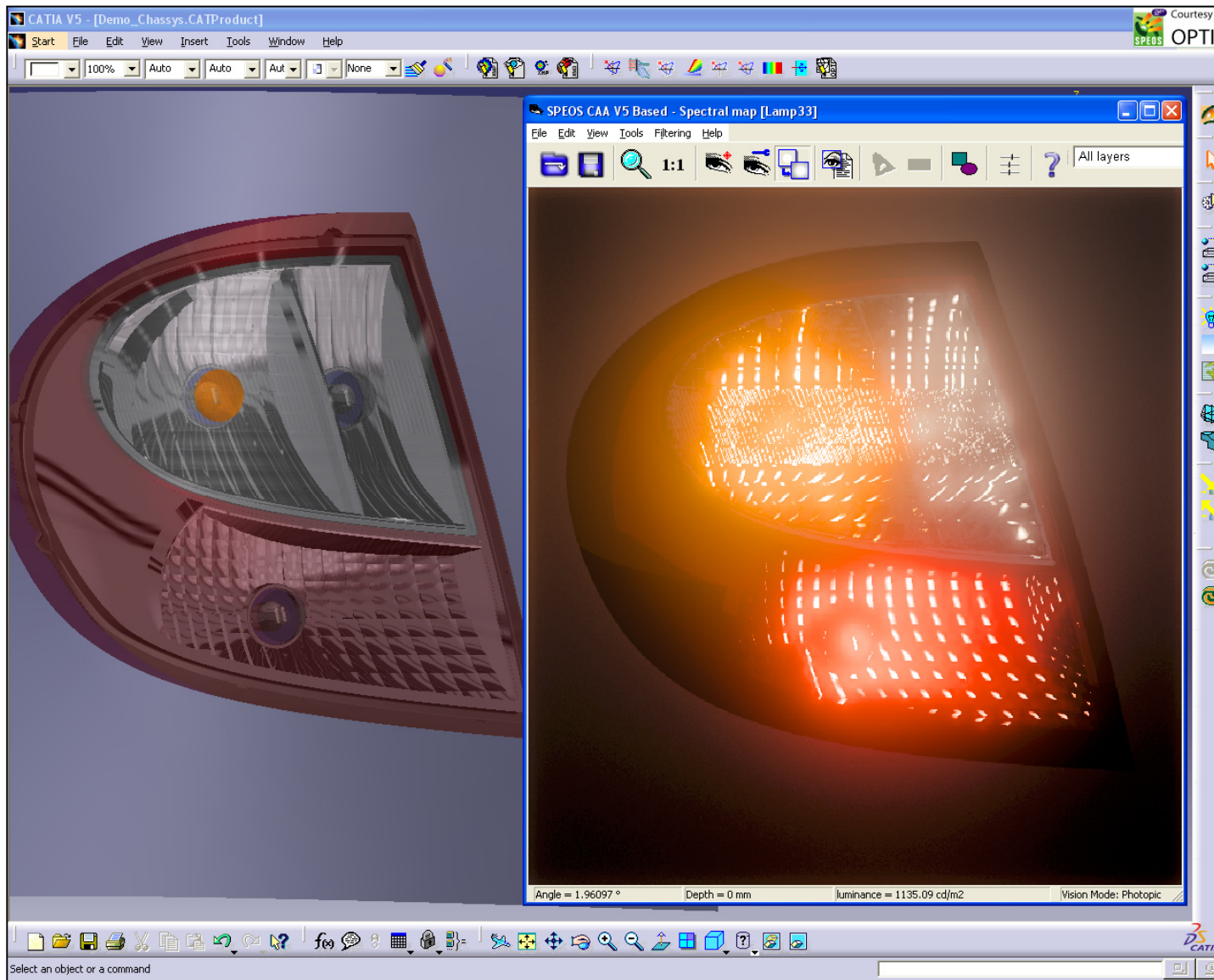

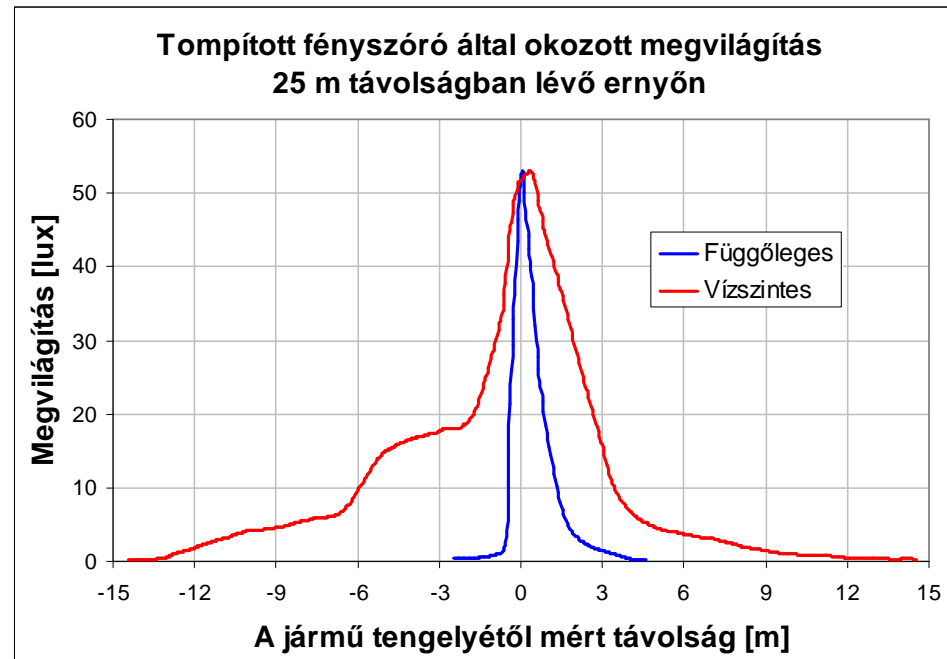
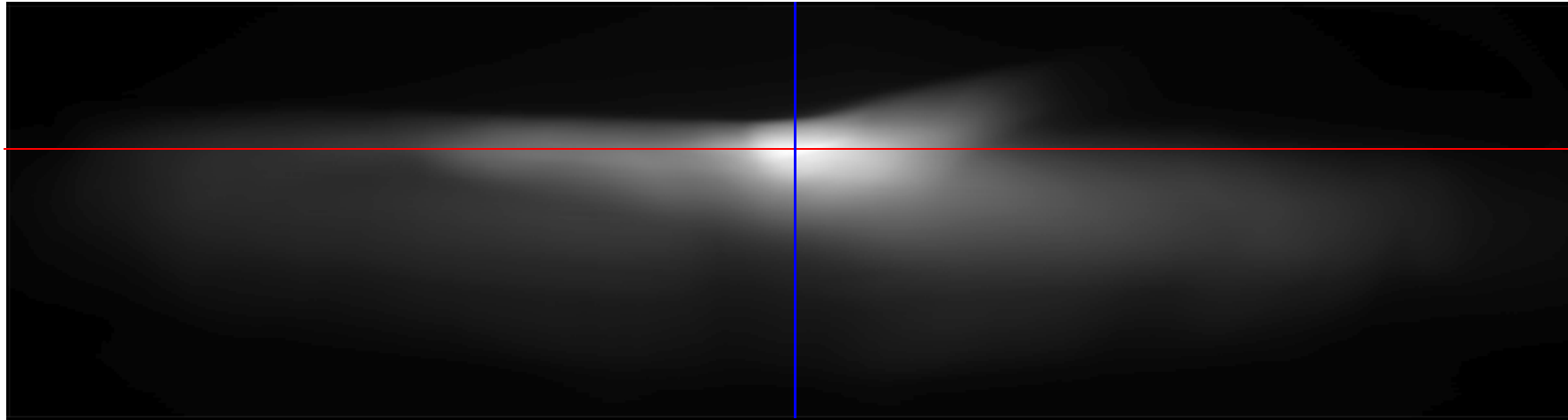







paraboloid  
tükör

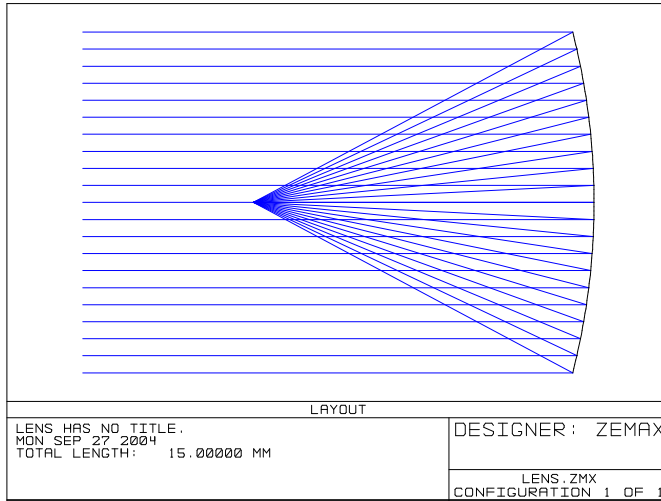

ellipszoid  
tükör

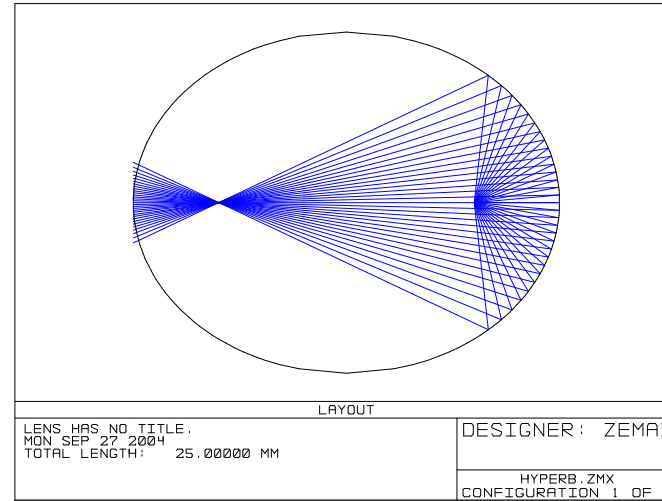

hiperboloid  
lencse

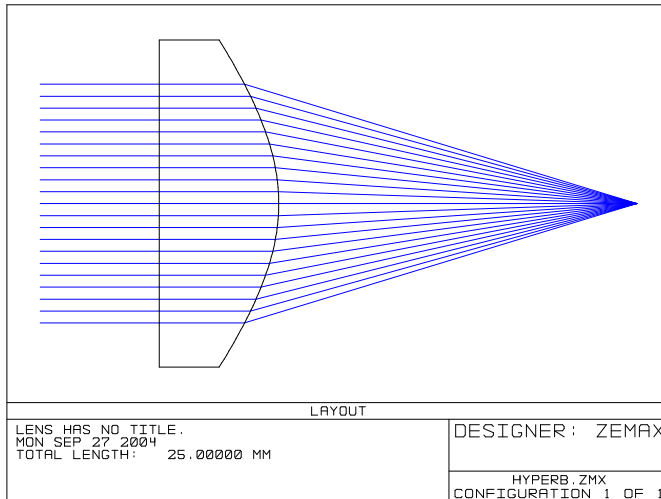

ellipszoid  
lencse

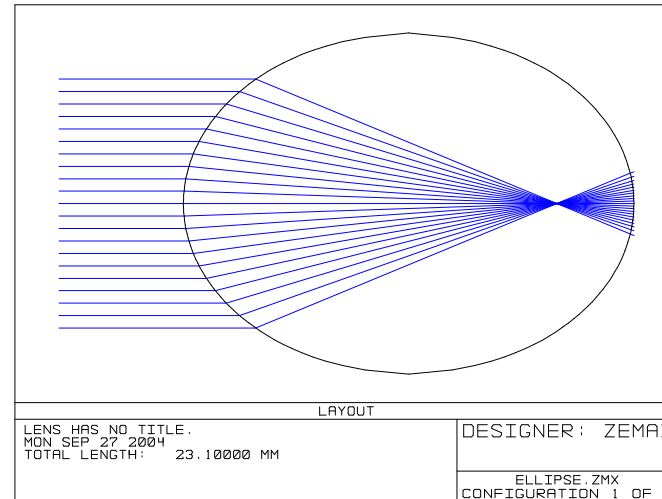



# ▪ Fókusz távolság meghatározása ▪

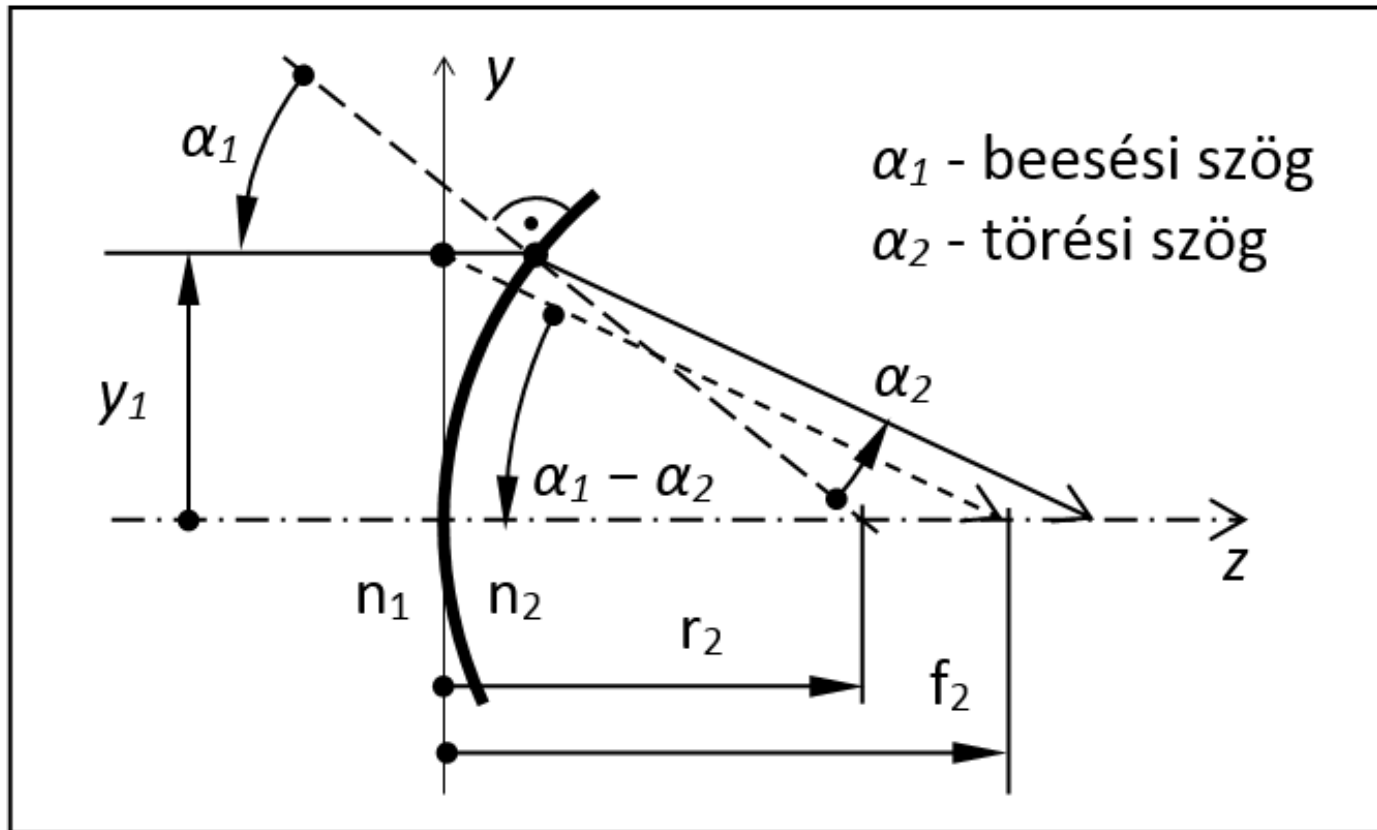



# ▪ Paraxiális sugár jellemzők ▪

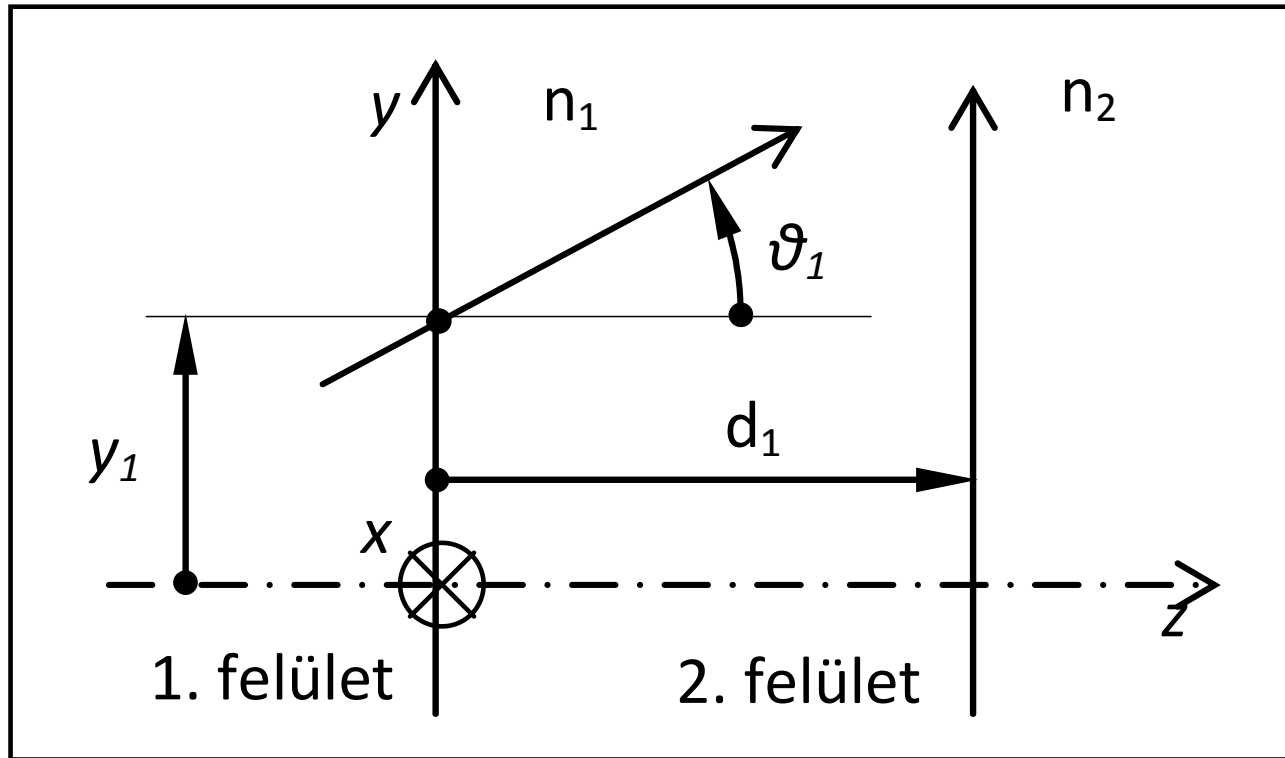





# ▪ Vékonylencsék jellemzői ▪

